



Overview of elements 2023

Ordering Information | Dimensional drawings

Ordering correctly

Necessary Order Information

Complete and accurate data is absolutely necessary for the processing and production of your order, since an accurate and clear order allows us to immediately begin processing your order without time-consuming enquiries.

For this reason, your order must contain the following information:

- Range name and front number
- Handle number
- Drill pattern number
- Carcase colour number
- Plinth height and colour
(if not specified, the standard plinth height of 150 mm will be supplied)
- Worktop design / décor
- Worktop edge design / edge colour
- Worktop sketch with dimensions and indication of tongue and groove joints
- Design of the worktop outer corner (for APD): square or round
- Upright / top shelf design including the colour number and upright thickness / Upright panel floor seal colour
- Shelf colours
- Glass design and / or colour
- Roll-up front colour
- Cornice profile / light pelmet profile including colour for each
- Order number and / or abbreviation
- Manufacturer information and built-in appliance model identification
- Kitchen block number (for kitchen block orders)
- Layout sketch with dimension information in 1:20 ratio
- Please draw / write any special productions in the centre of the layout sketch

Dimensional drawings for upright panels

Uprights at end of run for base units, sideboards and tall units are supplied as standard with an upright panel shoe. The upright panel shoe is included in the price of the upright panel and is available in: 014 Stainless steel appearance, 010 Black. If no colour is specified in the order, the version 014 Stainless steel appearance will automatically be supplied.

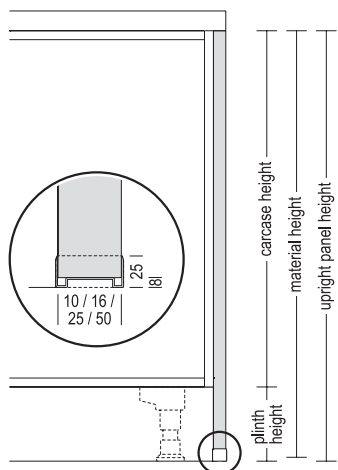

The height of the upright panel is reduced by the interior height dimensions of the profile and thus calculated as follows:

$$\begin{aligned} & \text{carcase height} \\ & + \text{plinth height} \\ & - 8 \text{ mm interior chamfering of the floor profile} \\ & = \text{material height} \end{aligned}$$

Base units

Carcase depth: 561 mm
 Carcase height: 720 mm
 Plinth height: 70, 100, 150 or 200 mm

Base units

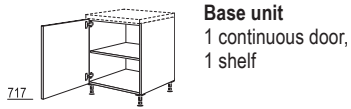

Base unit
 1 continuous door,
 1 shelf

717
UD 20/30/40/45/50/60 cm

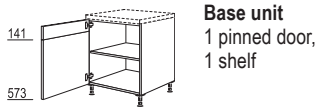

Base unit
 1 pinned door,
 1 shelf

141
 573
U 20/30/40/45/50/60 cm

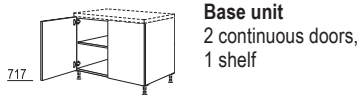

Base unit
 2 continuous doors,
 1 shelf

717
UD 80/90/100/120 cm

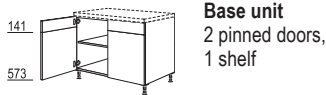

Base unit
 2 pinned doors,
 1 shelf

141
 573
U 80/90/100/120 cm

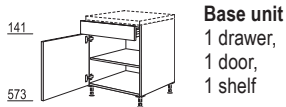

Base unit
 1 drawer,
 1 door,
 1 shelf

141
 573
US 30/40/45/50/60 cm



Base unit
 2 drawers,
 2 doors,
 1 shelf

141
 573
US 80/90/100/120 cm



Base unit
 1 drawer,
 2 doors,
 1 shelf

141
 573
USG 80/90/100/120 cm



Pull-out unit
 1 drawer,
 2 pull-outs

141
 285
 285
UA 30/40/45/50/60/80/90/100/120 cm



Drawer unit
 3 drawers,
 1 pull-out

141
 141
 141
 285
U3SA 30/40/45/50/60/80/90/100/120 cm

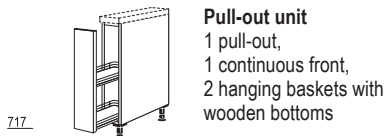

Pull-out unit
 1 pull-out,
 1 continuous front,
 2 hanging baskets with
 wooden bottoms

717
UAMD 20/30 cm



Open shelf base unit
 2 fixed shelves,
 side depth: 582 mm

UR 15/20/30/40/45/50/60 cm

Corner base units

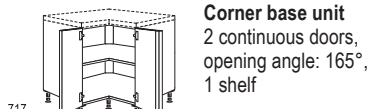

Corner base unit
 2 continuous doors,
 opening angle: 165°,
 1 shelf

717
UDTE 80/90 cm

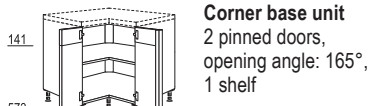

Corner base unit
 2 pinned doors,
 opening angle: 165°,
 1 shelf

141
 573
UTE 80/90 cm

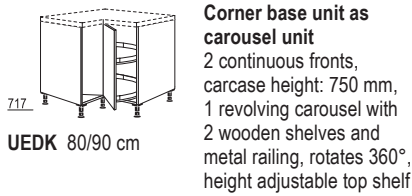

**Corner base unit as
 carousel unit**
 2 continuous fronts,
 carcase height: 750 mm,
 1 revolving carousel with
 2 wooden shelves and
 metal railing, rotates 360°,
 height adjustable top shelf

717
UEDK 80/90 cm

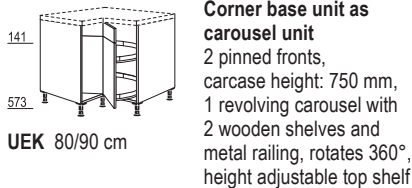

**Corner base unit as
 carousel unit**
 2 pinned fronts,
 carcase height: 750 mm,
 1 revolving carousel with
 2 wooden shelves and
 metal railing, rotates 360°,
 height adjustable top shelf

141
 573
UEK 80/90 cm

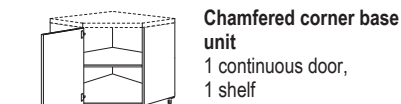

**Chamfered corner base
 unit**
 1 continuous door,
 1 shelf

717
UED 80/90 cm

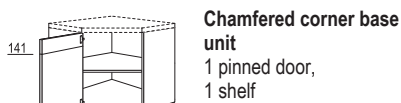

**Chamfered corner base
 unit**
 1 pinned door,
 1 shelf

141
 573
UE 80/90 cm

Half corner base units



Corner base unit
 1 continuous door,
 1 shelf,
 1 angle filler

717
UED90-40
UED90-45
UED100-50
UED100-60
 Carcase widths: 900, 1000 mm
 Planning dimensions (variable):
 650 (630 - 750) x ...
 *90-40: ... 1050 (1030 - 1150) mm
 *90-45: ... 1100 (1080 - 1200) mm
 *100-50: ... 1150 (1130 - 1250) mm
 *100-60: ... 1250 (1230 - 1350) mm

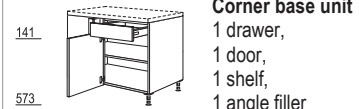

Corner base unit
 1 drawer,
 1 door,
 1 shelf,
 1 angle filler

141
 573
UE90-40
UE90-45
UE100-50
UE100-60
 Carcase widths: 900, 1000 mm
 Planning dimensions (variable):
 650 (630 - 750) x ...
 *90-40: ... 1050 (1030 - 1150) mm
 *90-45: ... 1100 (1080 - 1200) mm
 *100-50: ... 1150 (1130 - 1250) mm
 *100-60: ... 1250 (1230 - 1350) mm

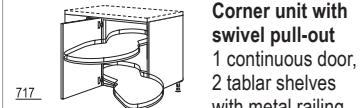

**Corner unit with
 swivel pull-out**
 1 continuous door,
 2 tablar shelves
 with metal railing,
 height adjustable,
 1 angle filler

717
UEDSA90-45
UEDSA100-50
UEDSA100-60
 Carcase widths: 900, 1000 mm
 Planning dimensions (variable):
 650 (630 - 750) x ...
 *90-45: ... 1100 (1080 - 1200) mm
 *100-50: ... 1150 (1130 - 1250) mm
 *100-60: ... 1250 (1230 - 1350) mm

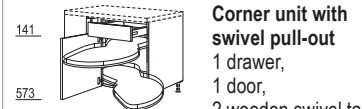

**Corner unit with
 swivel pull-out**
 1 drawer,
 1 door,
 2 wooden swivel tablars
 with metal railing,
 height adjustable,
 1 angle filler

141
 573
UESA90-45
UESA100-50
UESA100-60
 Carcase widths: 900, 1000 mm
 Planning dimensions (variable):
 650 (630 - 750) x ...
 *90-45: ... 1100 (1080 - 1200) mm
 *100-50: ... 1150 (1130 - 1250) mm
 *100-60: ... 1250 (1230 - 1350) mm

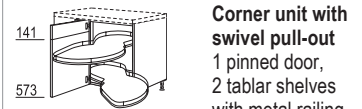

**Corner unit with
 swivel pull-out**
 1 pinned door,
 2 tablar shelves
 with metal railing,
 height adjustable,
 1 angle filler

141
 573
UESAV90-45
UESAV100-50
UESAV100-60
 Carcase widths: 900, 1000 mm
 Planning dimensions (variable):
 650 (630 - 750) x ...
 *90-45: ... 1100 (1080 - 1200) mm
 *100-50: ... 1150 (1130 - 1250) mm
 *100-60: ... 1250 (1230 - 1350) mm

**Surcharge for
 dishwasher recessed filler**
 on fillers and half-corner
 units, side panel made of
 carcase material,
 carcase depth: 561 mm

MP-GS

Base units

Carcase depth: 561 mm
 Carcase height: 720 mm
 Plinth height: 70, 100, 150 oder 200 mm

Angle fillers

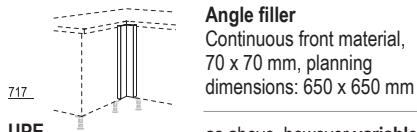

UPE
UPE-V

Angle filler
 Continuous front material,
 70 x 70 mm, planning
 dimensions: 650 x 650 mm

as above, however **variable**
 from 50 to 170 mm, planning
 dimensions: 630 - 750 mm
 1st dimension = left /
 2nd dimension = right

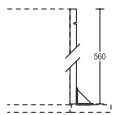

MP-GS

**Surcharge for
 dishwasher recessed filler**
 on fillers and half-corner
 units, side panel made of
 carcase material,
 carcase depth: 561 mm

Fillers / Panelling

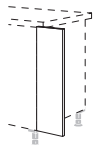

UPK 10/20 cm

Filler
 Carcase material,
 720 mm high,
 U-shaped seal for
 connection to wall,
 width: 100 / 200 mm

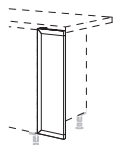

UPD 20 cm

Front filler
 Continuous front material,
 width: 200 mm

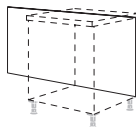

RK-72

Base unit back panel
 16 mm thick,
 720 mm high,
 width: 250 - 2000 mm,
 available in all carcase and
 worktop décors from décor
 group 1,
 Vario clip fastening,
 in case of reproduction
 finishes vertical wood grain

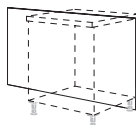

RKS-72

as above, however,
 continuous height,
 including floor profile:
 70 mm plinth height:
 810 mm
 100 mm plinth height:
 840 mm
 150 mm plinth height:
 890 mm
 200 mm plinth height:
 940 mm

**Available floor profile
 colours:**
 010 Black
 014 Stainless steel
 appearance

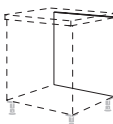

RFD-72
 30/40/45/50/60/80/90 cm

Base unit back panel
 1 continuous front design,
 720 mm high,
 Vario clip fastening,
without drill hole

Cooker housing

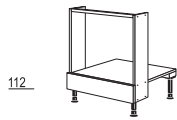

HU 60 cm

Cooker housing
 1 fixed panel,
 side sections: 177 mm deep,
 aperture dimension: 591 mm

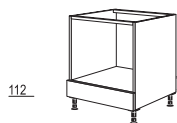

HUB 60 cm

Cooker housing
 1 fixed panel,
 aperture dimension: 598 mm

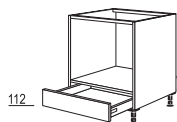

HUS 60 cm

Cooker housing
 1 plastic drawer,
 16 l capacity,
 interior dimensions:
 485 x 480 x 68 mm,
 aperture dimension: 598 mm

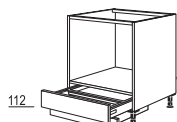

HUG 60 cm

Cooker housing
 1 large-capacity drawer with
 second level for baking trays,
 plastic, 30 l capacity,
 interior dimensions:
 480 x 380 x 150 mm,
 aperture dimension: 598 mm

Hot plate units

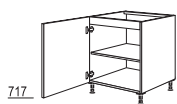

KD60 60 cm

Hot plate unit
 1 internal panel,
 1 construction shelf for
 heat insulation,
 1 door,
 1 shelf

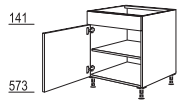

K60 60 cm

Hot plate unit
 1 fixed panel,
 1 construction shelf for
 heat insulation,
 1 door,
 1 shelf

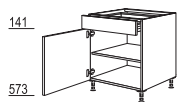

KS60 60 cm

Hot plate unit
 1 drawer,
 1 spacer shelf for hot plate,
 1 door,
 1 shelf

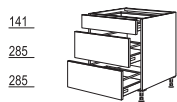

KS2A
 60/80/90/100/120 cm

Hot plate unit
 1 drawer,
 1 spacer shelf for hot plate,
 2 pull-outs



KD2A
 60/80/90/100/120 cm

Hot plate unit
 1 internal panel,
 1 construction shelf for heat
 insulation,
 2 pull-outs

Sink units

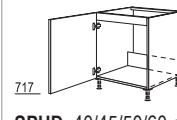

SPUD 40/45/50/60 cm

Sink base unit
 1 internal panel,
 1 continuous door

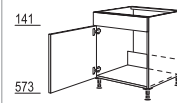

SPU 40/45/50/60 cm

Sink base unit
 1 fixed panel,
 1 door

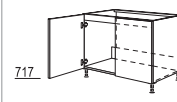

SPUD 80/90/100/120 cm

Sink base unit
 2 internal panels,
 2 continuous doors

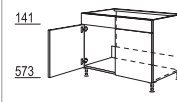

SPU 80/90/100/120 cm

Sink base unit
 2 fixed panels,
 2 doors

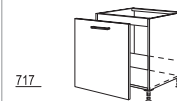

SPUAD
 40/45/50/60 cm

Sink base unit
 1 internal panel,
 1 continuous front with
 centred handle,
without pull-out rails and
 drill holes

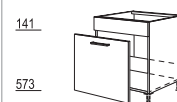

SPUA 40/45/50/60 cm

Sink base unit
 1 fixed panel,
 1 front with centred handle,
without pull-out rails and
 drill holes

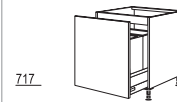

SPUDA-ASK
 45/50/60 cm

**Sink base unit
 Separato-K**
 1 internal panel,
 1 pull-out, 500 mm deep, with
**waste separation system
 Separato-K**
 with pull-out lid,
 1 x 18 and 2 x 8 litres,
 500 mm width: with
 1 side organiser,
 600 mm width: with
 2 side organisers,
 1 bio lid (for all widths)



1450/500/600l

Doors for integrated appliances

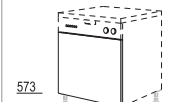

GSB 45/60 cm

Door
 for integrated
 dishwashers,
 without handle

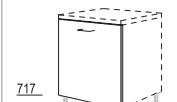

GSBD*-I 45/60 cm

Continuous door
 for fully integrated
 dishwashers,
 built-under fridge and
 freezer units
 with pull-outs

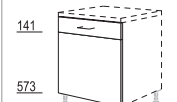

GSB*-I 45/60 cm



Pinned door
 for fully integrated
 dishwashers,
 built-under fridge and
 freezer units
 with pull-outs

Base units in XL height



Carcase depth: 561 mm
 Carcase height: 792 mm
 Plinth height: 70, 100, 150 or 200 mm

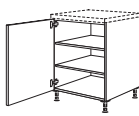
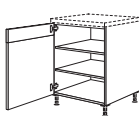
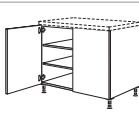
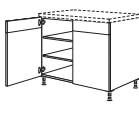
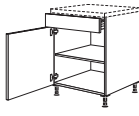
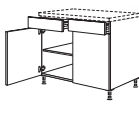

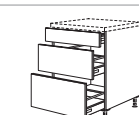
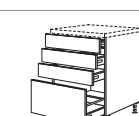
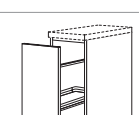
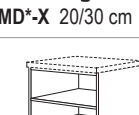

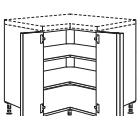
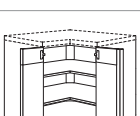
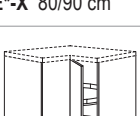
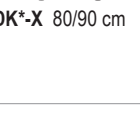

XL Base units

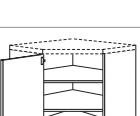
	XL Base unit 1 continuous door, 2 shelves
789	UD*-X 20/30/40/45/50/60 cm
	XL Base unit 1 pinned door, 2 shelves
141 645	U*-X 20/30/40/45/50/60 cm
	XL Base unit 2 continuous doors, 2 shelves
789	UD*-X 80/90/100/120 cm
	XL Base unit 2 pinned doors, 2 shelves
141 645	U*-X 80/90/100/120 cm
	XL Base unit 1 drawer, 1 door, 1 shelf
141 645	US*-X 30/40/45/50/60 cm
	XL Base unit 2 drawers, 2 doors, 1 shelf
141 645	US*-X 80/90/100/120 cm
	XL Base unit 1 drawer, 2 doors, 1 shelf
141 645	USG*-X 80/90/100/120 cm
	XL Pull-out unit 1 drawer, 2 pull-outs
141 285 357	UA*-X 30/40/45/50/60/80/90/100/120 cm
	XL Drawer unit 3 drawers, 1 pull-out
141 141 141 357	U3SA*-X 30/40/45/50/60/80/90/100/120 cm
	XL Pull-out unit 1 pull-out, 1 continuous front, 2 hanging baskets with wooden bottoms
789	UAMD*-X 20/30 cm
	XL Open shelf base unit 2 fixed shelves, side depth: 582 mm
	UR*-X 15/20/30/40/45/50/60 cm

XL Corner base units

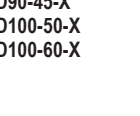
	XL Corner base unit 2 continuous doors, opening angle: 165°, 2 shelves
789	UDTE*-X 80/90 cm
	XL Corner base unit 2 pinned doors, opening angle: 165°, 2 shelves
141 645	UTE*-X 80/90 cm
	XL Corner base unit as carousel unit 2 continuous fronts, Unit height: 822 mm, 1 revolving carousel with 2 wooden shelves and metal railing, rotates 360° height adjustable top shelf
789	UEDK*-X 80/90 cm
	XL Corner base unit as carousel unit 2 pinned fronts, Unit height: 822 mm, 1 revolving carousel with 2 wooden shelves and metal railing, rotates 360° height adjustable top shelf
141 645	UEK*-X 80/90 cm
	XL Chamfered corner base unit 1 continuous door, 2 shelves
789	UED*-X 80/90 cm
	XL Chamfered corner base unit 1 pinned door, 2 shelves
141 645	UE*-X 80/90 cm

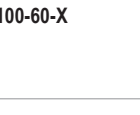
XL Half-corner units

	XL Corner base unit 1 continuous door, 2 shelves, 1 angle filler Carcase widths: 900, 1000 mm Planning dimensions (variable): 650 (630 - 750) x ... *90-40: ... 1050 (1030 - 1150) mm *90-45: ... 1100 (1080 - 1200) mm *100-50: ... 1150 (1130 - 1250) mm *100-60: ... 1250 (1230 - 1350) mm
789	UED90-40-X UED90-45-X UED100-50-X UED100-60-X
	XL Corner base unit 1 drawer, 1 door, 1 shelf, 1 angle filler Carcase widths: 900, 1000 mm Planning dimensions (variable): 650 (630 - 750) x ... *90-40: ... 1050 (1030 - 1150) mm *90-45: ... 1100 (1080 - 1200) mm *100-50: ... 1150 (1130 - 1250) mm *100-60: ... 1250 (1230 - 1350) mm
141 645	UE90-40-X UE90-45-X UE100-50-X UE100-60-X
	XL Corner unit with swivel pull-out 1 continuous door, 2 wooden swivel tablers with metal railing, height adjustable, 1 angle filler Carcase widths: 900, 1000 mm Planning dimensions (variable): 650 (630 - 750) x ... *90-45: ... 1100 (1080 - 1200) mm *100-50: ... 1150 (1130 - 1250) mm *100-60: ... 1250 (1230 - 1350) mm
789	UEDSA90-45-X UEDSA100-50-X UEDSA100-60-X
	XL Corner unit with swivel pull-out 1 drawer, 1 door, 2 wooden swivel tablers with metal railing, height adjustable, 1 angle filler Carcase widths: 900, 1000 mm Planning dimensions (variable): 650 (630 - 750) x ... *90-45: ... 1100 (1080 - 1200) mm *100-50: ... 1150 (1130 - 1250) mm *100-60: ... 1250 (1230 - 1350) mm
141 645	UESA90-45-X UESA100-50-X UESA100-60-X
	XL Corner unit with swivel pull-out 1 pinned door, 2 wooden swivel tablers with metal railing, height adjustable, 1 angle filler Carcase widths: 900, 1000 mm Planning dimensions (variable): 650 (630 - 750) x ... *90-45: ... 1100 (1080 - 1200) mm *100-50: ... 1150 (1130 - 1250) mm *100-60: ... 1250 (1230 - 1350) mm
141 645	UESAV90-45-X UESAV100-50-X UESAV100-60-X
	Surcharge for recessed fillers for fillers and half corner units, side section of carcase material, in carcase height, carcase depth: 561 mm
	MP-GS

Base units in XL height

Carcase depth: 561 mm
 Carcase height: 792 mm
 Plinth height: 70, 100, 150 or 200 mm



XL Angle fillers

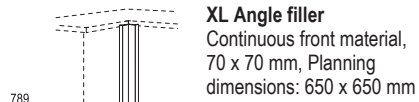

UPE-X
 UPE-V-X

XL Angle filler
 Continuous front material,
 70 x 70 mm, Planning
 dimensions: 650 x 650 mm

as above, however **variable**
from 50 to 170 mm, Planning
 dimensions: 630 - 750 mm
 1st dimension = left
 2nd dimension = right

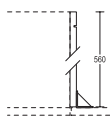

MP-GS

Surcharge for recessed fillers
 for fillers and half corner
 units, side section of
 carcase material,
 in carcase height,
 carcase depth: 561 mm

XL Fillers / Panelling

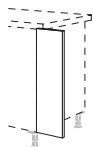

UPK*-X 10/20 cm

XL Filler
 Carcase material,
 792 mm high,
 U-shaped seal for
 connection to wall,
 width: 100 / 200 mm

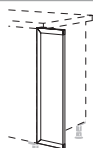

UPD*-X 20 cm

XL Front filler
 Continuous front material,
 width: 200 mm

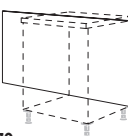

RK-79

XL Base unit back panel
 16 mm thick,
 792 mm high,
 width: 250 - 2000 mm,
 available in all carcase and
 worktop décors from décor
 group 1,
 Vario clip fastening,
 in case of reproduction
 finishes vertical wood grain

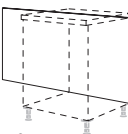

RKS-79

as above, however,
 continuous height,
 including floor profile:
 70 mm plinth height:
 882 mm
 100 mm plinth height:
 912 mm
 150 mm plinth height:
 962 mm
 200 mm plinth height:
 1012 mm

Available floor profile colours:
 010 Black
 014 Stainless steel
 appearance

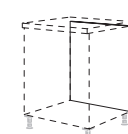

RFD*-79
 30/40/45/50/60 cm

XL Base unit back panel
 1 continuous front,
 789 mm high,
 Vario clip fastening,
 without drill holes

XL Cooker housings

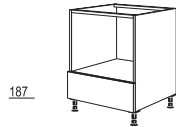

187

HUB-X 60 cm

XL Cooker housing
 1 fixed panel,
 aperture dimension: 595 mm

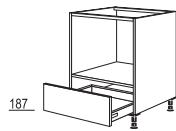

187

HUS*-X 60 cm

XL Cooker housing
 1 plastic drawer,
 16 l capacity,
 interior dimensions:
 485 x 480 x 68 mm
 aperture dimension: 595 mm

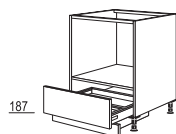

187

HUG-X 60 cm

XL Cooker housing
 1 large-capacity drawer
 with second level for baking
 trays, plastic, 30 l capacity,
 interior dimensions:
 480 x 380 x 150 mm,
 aperture dimension: 595 mm

XL Hot plate units



789

KD60-X 60 cm

XL Hot plate unit
 1 internal panel,
 1 construction shelf for heat
 insulation,
 1 door,
 2 shelves

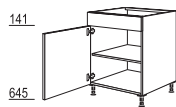

141

K60-X 60 cm

XL Hot plate unit
 1 fixed panel,
 1 construction shelf for heat
 insulation,
 1 door,
 1 shelf



141

KS60-X 60 cm

XL Hot plate unit
 1 drawer,
 1 spacer shelf for hot plate,
 1 door,
 1 shelf



141

KS2A*-X
 60/80/90/100/120 cm

XL Hot plate unit
 1 drawer,
 1 spacer shelf for hot plate,
 2 pull-outs

XL-Doors for integrated appliances

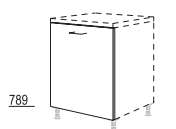

789

GSBD*-I-X 45/60 cm

Continuous XL door
 for fully integrated
 dishwashers,
 built-under fridge and
 freezer units
 with pull-outs,
 includes spacer strip

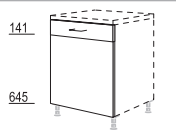

141

GSB*-I-X 45/60 cm

Pinned XL door
 for fully integrated
 dishwashers,
 built-under fridge and
 freezer units
 with pull-outs,
 includes spacer strip

XL Sink base units

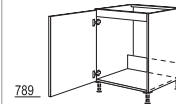

789

SPUD*-X 40/45/50/60 cm

XL Sink base unit
 1 internal panel,
 1 continuous door

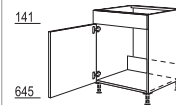

141

SPU*-X 40/45/50/60 cm

XL Sink base unit
 1 fixed panel,
 1 door

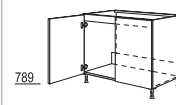

789

SPUD*-X 80/90/100/120 cm

XL Sink base unit
 2 internal panels,
 2 continuous doors

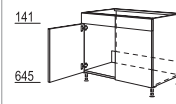

141

SPU*-X 80/90/100/120 cm

XL Sink base unit
 2 fixed panels,
 2 doors

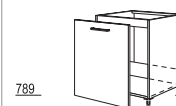

789

SPUAD*-X
 40/45/50/60 cm

XL Sink base unit
 1 internal panel,
 1 continuous front with
 centred handle,
 without pull-out rails and
 drill holes

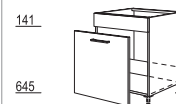

141

SPUA*-X 40/45/50/60 cm

XL Sink base unit
 1 fixed panel,
 1 front with centred handle,
 without pull-out rails and
 drill holes



789

SPUDA-ASK*-X
 45/50/60 cm

XL Sink unit Separato-K
 1 internal panel,
 1 pull-out, 500 mm deep, with
waste separation system
Separato-K
 with pull-out lid,
 1 x 18 and 2 x 8 litres,
 500 mm width: with
 1 side organiser,
 600 mm width: with
 2 side organisers,
 1 bio lid (for all widths)

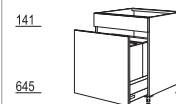
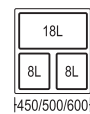

141

SPUA-ASK*-X
 45/50/60 cm

XL Sink unit Separato-K
 1 fixed panel,
 1 pull-out, 500 mm deep, with
waste separation system
Separato-K
 with pull-out lid,
 1 x 18 and 2 x 8 litres,
 500 mm width: with
 1 side organiser,
 600 mm width: with
 2 side organisers,
 1 bio lid (for all widths)

Worktops | Niche cladding

Worktops

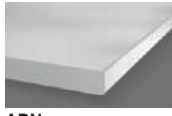

APN
60/70/80/90/100/
110/120 cm

Worktop APN with N-edge
rounded front edge, sides sealed with straight décor edge.
Price per running 100 mm, every 100 mm started will be invoiced.
Maximum 5100 mm wide.
Please quote the décor number in your order.

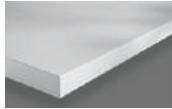

APD
60/70/80/90/100/
110/117 cm

Worktop APD with décor edge
front and side edges coated with straight décor edging material, 1.5 mm thick.
Price per running 100 mm, every 100 mm started will be invoiced.
Maximum 5100 mm wide.
Please quote the décor and edge colour number in your order.

Worktop processing

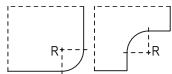

AP-R

Surcharge for exterior and interior roundings deviating from the standard radii on worktops

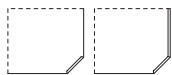

**APN-A
APN-AS
APD-A**

Surcharge for chamfered cuts
on worktops and tables, including edging



AP-NF

Tongue and groove joint
for worktop corners or extensions, incl. screw fittings, tongues and water resistant glue



AP-AUS

Cut-outs for built in hobs, sinks or ventilation grills

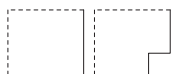

AP-IEK

Surcharge for inner corners in square design
on worktops and tables with décor edge

Niche cladding



**NV 54
NV 70**

Niche cladding
coated on both faces, 16 mm thick,
horizontal structure (except 226 Metal art décor and 274 Teramo marble reproduction)
with edge on all sides, width: 250 - 2580 mm
heights:
NV54 for niches beneath wall units
NV70 for niches beneath cooker hoods

Price per started 100 mm.

NV 203

Niche cladding as above, **however with deviating dimensions acc. to sketch**
max. 2580 mm wide, 2030 mm high,
1st dimension in direction of grain
coated edge all round.
Minimum price: 0.5 m²,
minimum dimensions: 250 x 200 mm,
invoiced per m².

Accessories for niche cladding



NPUK 500

Plastic cover profile in translucent appearance
for niche or back panel cladding,
16 mm thick, self-adhesive, 5000 mm long



WAPN
200/400/500 cm

Upstands for continuous planning with niche cladding
2-piece plastic profile with sealing lip, incl. vertical sealing profile
dimensions: 25 mm high, 25 mm deep,
delivered as strand material.

Available in:
014 Stainless steel appearance, 010 Black



WAPN-Z

WAPN accessory bag
matches the plastic upstands WAPN
consisting of:
4 x interior corner 90° /
2 x interior corner 135°
2 x exterior corner 90°
2 x set of end caps for WAPN
2 x set of end caps for niche cladding

Available in:
014 Stainless steel appearance, 010 Black



NKPU 200 / 400

Aluminium profile, 2-piece with sealing profile
for niche and back panel cladding or as upstand,
dimensions:
17 mm high, 20 mm deep

Available in:
014 Stainless steel appearance, 010 Black



NKPO 200 / 400

Niche profile on top aluminium profile, stainless steel appearance
for niche cladding incl. 1 set of end caps (left / right),
dimensions:
16 mm high, 16 mm deep



NKP-Z

NKP accessory bag
matches upstand NKPU
Available in:
014 Stainless steel appearance, 010 Black



NKP-EK

1 set of end caps
matching aluminium profile for niche cladding NKPO

Upright panels | Top shelves | Wall shelf units

Upright panels for base units

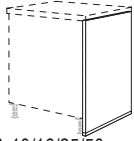

UWA 10/16/25/50 mm

Upright at end of run
incl. floor profile in
014 Stainless steel
appearance or
010 Black,
depth: 583 mm

Plinth height 70 mm: 790 mm
Plinth height 100 mm: 820 mm
Plinth height 150 mm: 870 mm
Plinth height 200 mm: 920 mm

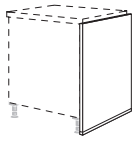

UWR 10/16/25/50 mm

Upright for room designs
depth: 250 to 1166 mm,
edged on both sides,
incl. floor profile in
014 Stainless steel
appearance or
010 Black

Plinth height 70 mm: 790 mm
Plinth height 100 mm: 820 mm
Plinth height 150 mm: 870 mm
Plinth height 200 mm: 920 mm

Upright panels for wall units

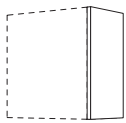

WW 10/16/25/50 mm -1

**Upright at end of run /
intermediate upright for
wall units,
height 1**
depth: 372 mm,
height: 720 mm

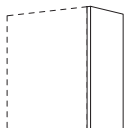

WW 10/16/25/50 mm -2

**Upright at end of run /
intermediate upright for
wall units,
height 2**
depth: 372 mm,
height: 792 mm

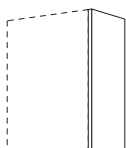

WW 10/16/25/50 mm -3

**Upright at end of run /
intermediate upright for
wall units,
height 3**
depth: 372 mm,
height: 864 mm

XL Upright panels for base units

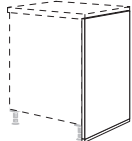

UWA*-X 10/16/25/50 mm

XL Upright at end of run
incl. floor seal in
014 Stainless steel
appearance or
010 Black,
depth: 583 mm

Plinth height 70 mm: 862 mm
Plinth height 100 mm: 892 mm
Plinth height 150 mm: 942 mm
Plinth height 200 mm: 992 mm

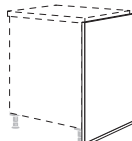

UWR*-X 10/16/25/50 mm

XL Upright for room designs
depth: 250 to 1166 mm,
edged on both sides,
incl. floor seal in
014 Stainless steel
appearance or
010 Black

Plinth height 70 mm: 862 mm
Plinth height 100 mm: 892 mm
Plinth height 150 mm: 942 mm
Plinth height 200 mm: 992 mm

Top shelves



ADB10 38/59/117 cm

**Top shelf,
10 mm thick,
for side- or highboard**
coated on both faces,
polymer edged on front
and sides,
length: 250 - 2580 mm



ADB16 38/59/117 cm

**Top shelf,
16 mm thick,
for side- or highboard**
coated on both faces,
polymer edged on front
and sides,
length: 250 - 2580 mm



ADB25 38/59/117 cm

**Top shelf,
25 mm thick,
for side- or highboard**
coated on both faces,
polymer edged on front
and sides,
length: 250 - 2580 mm

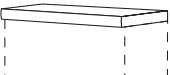

ADB50 38/59/117 cm

**Top shelf,
50 mm thick,
for side- or highboard**
coated on both faces,
polymer edged on front
and sides,
length: 250 - 2580 mm

Wall shelf units

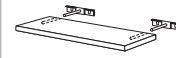

WB25 30/40/45/50/55/
60/65/70/80/90/
100/110/120 cm

**Plug-in wall shelf,
25 mm thick**
Carcase material,
polymer edging all around,
255 mm deep,
incl. metal plug fitting



VB16 100 cm

**Wall shelf unit with shelf
holders, 16 mm thick**
255 mm deep,
polymer edging all round,
**available in widths from
250 mm to 1000 mm,**
includes 2 shelf holders
VBH5

VB16 258 cm

Wall shelf unit with shelf
holders as above,
**however available in
widths from 1001 mm to
2580 mm,**
includes 4 shelf holders
VBH5

**Available shelf holder
colours:**
010 Black
014 Stainless steel
appearance

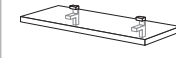

VB25 100 cm

**Wall shelf unit with shelf
holders, 25 mm thick**
255 mm deep,
polymer edging all round,
**available in widths from
250 mm to 1000 mm,**
includes 2 shelf holders
VBH5

VB25 258 cm

Wall shelf unit with shelf
holders as above,
**however available in
widths from 1001 mm to
2580 mm,**
includes 4 shelf holders
VBH5

**Available shelf holder
colours:**
010 Black
014 Stainless steel
appearance

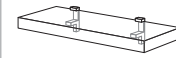

VB50 100 cm

**Wall shelf unit with shelf
holders, 50 mm thick**
255 mm deep,
polymer edging all round,
**available in widths from
250 mm to 1000 mm,**
includes 2 shelf holders
VBH5

VB50 258 cm

Wall shelf unit with shelf
holders as above,
**however available in
widths from 1001 mm to
2580 mm,**
includes 4 shelf holders
VBH5

**Available shelf holder
colours:**
010 Black
014 Stainless steel
appearance

Highboards – 1582 / 1612 / 1662 / 1712 mm high

Carcase depth: 561 mm
 Carcase height: 1512 mm
 Plinth height: 70, 100, 150 oder 200 mm

XL Highboards – 1654 / 1684 / 1734 / 1784 mm high

Carcase depth: 561 mm
 Carcase height: 1584 mm
 Plinth height: 70, 100, 150 oder 200 mm



Highboards

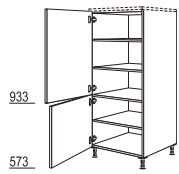

Highboard
 2 doors,
 1 fixed shelf,
 3 shelves

H 30/40/50/60 cm

XL Highboards

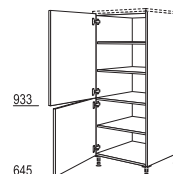

XL Highboard
 2 doors,
 1 fixed shelf,
 3 shelves

H*-X 30/40/50/60 cm

Housing for ovens

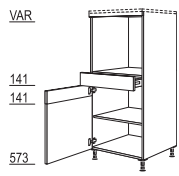

Oven housing
 aperture height: 590 mm
 1 fixed compensation panel,
 1 drawer,
 1 pinned door,
 1 shelf

GOS

XL Housing for ovens

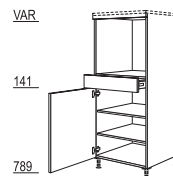

XL Oven housing
 aperture height: 590 mm
 1 fixed compensation panel,
 1 drawer,
 1 door,
 2 shelves

GDOS-X

Integrated appliance housings with aperture height up to 880 mm

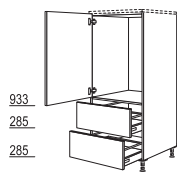

Appliance housing for integrated fridge
 aperture height: 880 mm
 1 appliance door,
 2 pull-outs

G88A

XL Integrated appliance housings with aperture height up to 880 mm

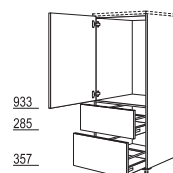

XL Appliance housing for integrated fridge
 aperture height: 880 mm
 1 appliance door,
 2 pull-outs

G88A-X

Integrated appliance housings with aperture height up to 1230 mm

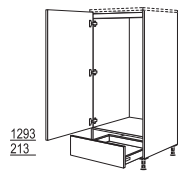

Appliance housing for integrated fridge
 aperture height: 1230 mm
 1 internal panel,
 1 appliance door,
 1 drawer

G123S

XL Integrated appliance housings with aperture height up to 1230 mm

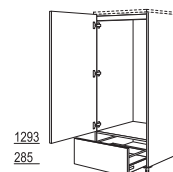

XL Appliance housing for integrated fridge
 aperture height: 1230 mm
 1 internal panel,
 1 appliance door,
 1 pull-out

G123A-X

Appliance housings with aperture height up to 1450 mm

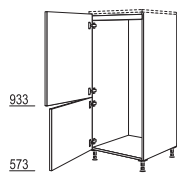

Appliance housing for integrated fridge / freezer
 aperture height: 1450 mm
 1 internal panel,
 2 appliance doors

G145

XL Appliance housings with aperture height up to 1450 mm

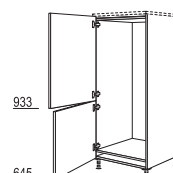

XL Appliance housing for integrated fridge / freezer
 aperture height: 1450 mm
 2 appliance doors

G145-X

Fillers

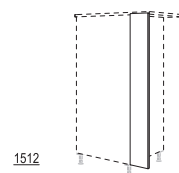

Filler
 Carcase material,
 1512 mm high,
 U-shaped seal for
 connection to wall,
 width: 230 mm

HPK 20 cm

XL Fillers

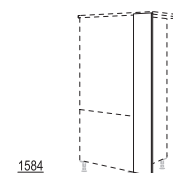

XL Filler
 Carcase material,
 1584 mm high,
 U-shaped seal for
 connection to wall,
 width: 230 mm

HPK20-X 20 cm

Tall units, height 1 – 2086 / 2116 / 2166 / 2216 mm high

Carcase depth: 561 mm
 Carcase height: 2016 mm
 Plinth height: 70, 100, 150 oder 200 mm

Tall units



501
 933
 573
H*-1 30/40/50/60 cm

Pantry unit
 3 doors,
 2 fixed shelves,
 4 shelves



1293
 717
HDV*-1 30/40/50/60 cm

Pantry unit
 2 doors,
 1 fixed shelf,
 4 shelves

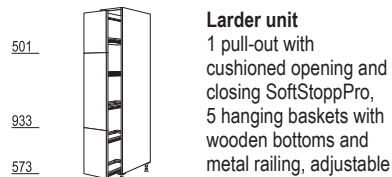

501
 933
 573
HA*-1 30/40 cm

Larder unit
 1 pull-out with
 cushioned opening and
 closing SoftStoppPro,
 5 hanging baskets with
 wooden bottoms and
 metal railing, adjustable

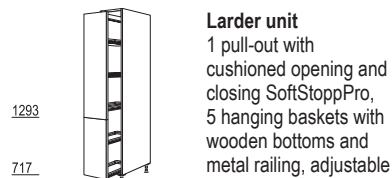

1293
 717
HDA*-1 30/40 cm

Larder unit
 1 pull-out with
 cushioned opening and
 closing SoftStoppPro,
 5 hanging baskets with
 wooden bottoms and
 metal railing, adjustable

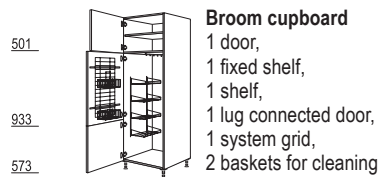

501
 933
 573
HB*-1 40/50/60 cm

Broom cupboard
 1 door,
 1 fixed shelf,
 1 shelf,
 1 lug connected door,
 1 system grid,
 2 baskets for cleaning
 materials,
 1 system shelf,
 1 hose rack for vacuum
 cleaner,
 2 pegboards

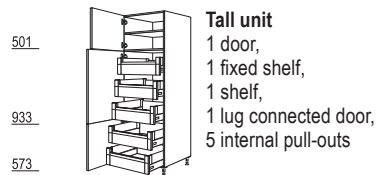

501
 933
 573
HI*-1 40/50/60 cm

Tall unit
 1 door,
 1 fixed shelf,
 1 shelf,
 1 lug connected door,
 5 internal pull-outs

Appliance housing for ovens, microwaves, steam cookers, compact appliances



645
 VAR
 717
GO-1

Oven housing
 aperture height: 590 mm
 2 doors,
 1 fixed compensation panel,
 2 shelves



645
 VAR
 141
 573
GOS-1

Oven housing
 aperture height: 590 mm
 2 doors,
 1 fixed compensation panel,
 1 drawer,
 2 shelves

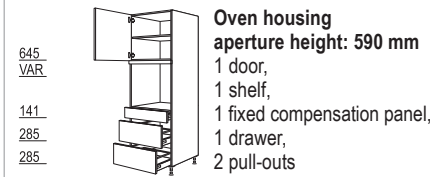

645
 VAR
 141
 285
 285
GOS2A-1

Oven housing
 aperture height: 590 mm
 1 door,
 1 shelf,
 1 fixed compensation panel,
 1 drawer,
 2 pull-outs

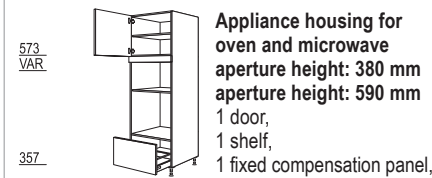

573
 VAR
 357
GMO-1

Appliance housing for oven and microwave
 aperture height: 380 mm
 aperture height: 590 mm
 1 door,
 1 shelf,
 1 fixed compensation panel,
 1 pull-out



357
 429
 VAR
 573
GLO-1

Appliance housing for oven and microwave with lifting door
 aperture height: 370 mm
 aperture height: 590 mm
 1 flap,
 1 lifting door,
 1 fixed compensation panel,
 1 door,
 1 shelf

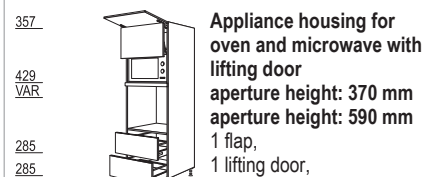

357
 429
 VAR
 285
 285
GLO2A-1

Appliance housing for oven and microwave with lifting door
 aperture height: 370 mm
 aperture height: 590 mm
 1 flap,
 1 lifting door,
 1 fixed compensation panel,
 2 pull-outs

Appliance housings with aperture height up to 880 mm

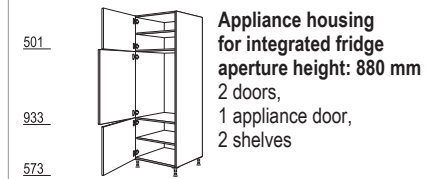

501
 933
 573
G88-1

Appliance housing for integrated fridge
 aperture height: 880 mm
 2 doors,
 1 appliance door,
 2 shelves

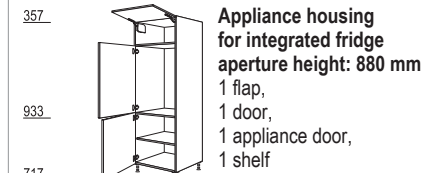

357
 933
 717
GD88-1

Appliance housing for integrated fridge
 aperture height: 880 mm
 1 flap,
 1 door,
 1 appliance door,
 1 shelf

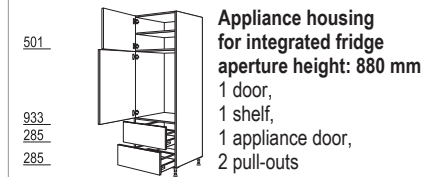

501
 933
 285
 285
G88A-1

Appliance housing for integrated fridge
 aperture height: 880 mm
 1 door,
 1 shelf,
 1 appliance door,
 2 pull-outs

Appliance housings with aperture height up to 1230 mm

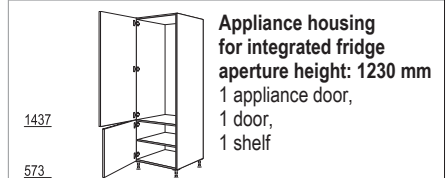

1437
 573
G123-1

Appliance housing for integrated fridge
 aperture height: 1230 mm
 1 appliance door,
 1 door,
 1 shelf

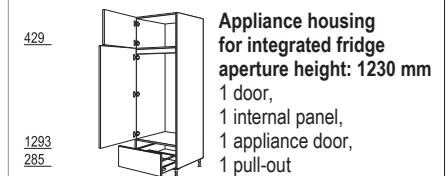

429
 1293
 285
G123A-1

Appliance housing for integrated fridge
 aperture height: 1230 mm
 1 door,
 1 internal panel,
 1 appliance door,
 1 pull-out

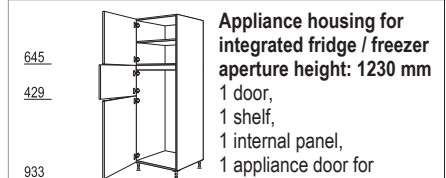

645
 429
 933
G123G-1

Appliance housing for integrated fridge / freezer
 aperture height: 1230 mm
 1 door,
 1 shelf,
 1 internal panel,
 1 appliance door for freezer compartment,
 1 appliance door for fridge section

Tall units, height 1 – 2086 / 2116 / 2166 / 2216 mm high

Carcase depth: 561 mm
 Carcase height: 2016 mm
 Plinth height: 70, 100, 150 oder 200 mm

Appliance housings with aperture height up to 1450 mm

573
1149
285

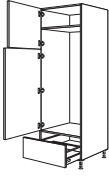

**Appliance housing for integrated fridge / freezer
aperture height: 1450 mm**
 1 appliance door for
freezer compartment,
 1 appliance door for
fridge section,
 1 pull-out

G145A-1

501
933
573



**Appliance housing for
integrated fridge / freezer
aperture height: 1450 mm**
 1 door,
 1 shelf,
 1 internal panel,
 2 appliance doors

G145-1

Appliance housings with aperture height between 1580 - 1940 mm

1293
717

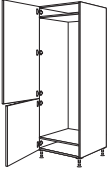

**Appliance housing
for fridge / freezer
aperture height:
1580 - 1940 mm**
 2 appliance doors

GD194-1

Fillers / Cladding

2016

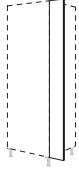

Filler
 Carcase material,
 2016 mm high,
 U-shaped seal for
 connection to wall,
 width: 230 mm

HPK20-1 20 cm

2013

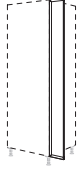

Front filler
 Continuous front material,
 width: 200 mm

HPD20-1 20 cm



Tall units in XL height, height 1 XL – 2158 / 2188 / 2238 / 2288 mm high



Carcase depth: 561 mm
 Carcase height: 2088 mm
 Plinth height: 70, 100, 150 oder 200 mm

XL Tall units

501
933
645

XL Pantry unit
 3 doors,
 2 fixed shelves,
 4 shelves

H*-1X 30/40/50/60 cm

1293
789

XL Pantry unit
 2 doors,
 1 fixed shelf,
 5 shelves

HDV*-1X 30/40/50/60 cm

501
933
645

XL Larder unit
 1 pull-out with
 cushioned opening and
 closing SoftStoppPro,
 6 hanging baskets with
 wooden bottoms and
 metal railing, adjustable

HA*-1X 30/40 cm

1293
789

XL Larder unit
 1 pull-out with
 cushioned opening and
 closing SoftStoppPro,
 6 hanging baskets with
 wooden bottoms and
 metal railing, adjustable

HDA*-1X 30/40 cm

501
933
645

XL Broom cupboard
 1 door,
 1 fixed shelf,
 1 shelf,
 1 lug connected door,
 1 system grid,
 2 baskets for cleaning
 materials,
 1 system shelf,
 1 hose rack for vacuum
 cleaner,
 2 pegboards

HB*-1X 40/50/60 cm

501
933
645

XL Tall unit
 1 door,
 1 fixed shelf,
 1 shelf,
 1 lug connected door,
 5 internal pull-outs

HI*-1X 40/50/60 cm

XL Appliance housing for ovens, micro-waves, steam cookers, compact appliances

645
VAR
789

XL Oven housing
 aperture height: 590 mm
 2 doors,
 1 fixed compensation panel,
 3 shelves

GO-1X

645
VAR
141
645

XL Oven housing
 aperture height: 590 mm
 2 doors,
 1 fixed compensation panel,
 1 drawer,
 2 shelves

GOS-1X

645
VAR
141
285
357

XL Oven housing
 aperture height: 590 mm
 1 door,
 1 shelf,
 1 fixed compensation panel,
 1 drawer,
 2 pull-outs

GOS2A-1X

573
VAR
429

XL Appliance housing for oven and microwave
 aperture height: 380 mm
 aperture height: 590 mm
 1 door,
 1 shelf,
 1 fixed compensation panel,
 1 pull-out

GMO-1X

357
429
VAR
645

XL Appliance housing for oven and microwave with lifting door
 aperture height: 370 mm
 aperture height: 590 mm
 1 flap,
 1 lifting door,
 1 fixed compensation panel,
 1 door,
 1 shelf

GLO-1X

357
429
VAR
285
357

XL Appliance housing for oven and microwave with lifting door
 aperture height: 370 mm
 aperture height: 590 mm
 1 flap,
 1 lifting door,
 1 fixed compensation panel,
 2 pull-outs

GLO2A-1X

XL Appliance housings with aperture height up to 880 mm

501
933
645

XL Appliance housing for integrated fridge
 aperture height: 880 mm
 2 doors,
 1 appliance door,
 2 shelves

G88-1X

357
933
789

XL Appliance housing for integrated fridge
 aperture height: 880 mm
 1 flap,
 1 appliance door,
 1 door,
 2 shelves

GD88-1X

501
933
285
357

XL Appliance housing for integrated fridge
 aperture height: 880 mm
 1 door,
 1 shelf,
 1 appliance door,
 2 pull-outs

G88A-1X

XL Appliance housings with aperture height up to 1230 mm

1437
645

XL Appliance housing for integrated fridge
 aperture height: 1230 mm
 1 appliance door,
 1 door,
 1 shelf

G123-1X

429
1293
357

XL Appliance housing for integrated fridge
 aperture height: 1230 mm
 1 door,
 1 internal panel,
 1 appliance door,
 1 pull-out

G123A-1X

645
429
1005

XL Appliance housing for integrated fridge / freezer
 aperture height: 1230 mm
 1 door,
 1 shelf,
 1 internal panel,
 1 appliance door for freezer compartment,
 1 appliance door for fridge section

G123G-1X

Tall units in XL height, height 1 XL – 2158 / 2188 / 2238 / 2288 mm high



Carcase depth: 561 mm
 Carcase height: 2088 mm
 Plinth height: 70, 100, 150 oder 200 mm

XL Appliance housings with aperture height up to 1450 mm

501
933
645

XL Appliance housing for integrated fridge / freezer aperture height: 1450 mm
 1 door,
 1 shelf,
 1 internal panel,
 2 appliance doors

G145-1X

573
1149
357

XL Appliance housing for integrated fridge / freezer aperture height: 1450 mm
 1 appliance door for freezer compartment,
 1 appliance door for fridge section,
 1 pull-out

G145A-1X

XL Appliance housings with aperture height between 1580 - 1940 mm

1293
789

XL Appliance housing for fridge / freezer aperture height: 1580 - 1940 mm
 2 appliance doors

GD194-1X

XL Fillers / Cladding

2088

XL Filler
 Carcase material,
 2088 mm high,
 U-shaped seal for connection to wall,
 width: 230 mm

HPK20-1X 20 cm

1293
789
2085

XL Front filler
 Continuous front material,
 width: 200 mm

HPD20-1X 20 cm



Tall units, height 2 – 2158 / 2188 / 2238 / 2288 mm high

Carcase depth: 561 mm
 Carcase height: 2088 mm
 Plinth height: 70, 100, 150 oder 200 mm

Tall units



Pantry unit
 3 doors,
 2 fixed shelves,
 4 shelves

H*-2 30/40/50/60 cm



Pantry unit
 2 doors,
 1 fixed shelf,
 4 shelves

HDV*-2 30/40/50/60 cm

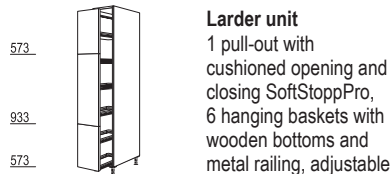

Larder unit
 1 pull-out with
 cushioned opening and
 closing SoftStoppPro,
 6 hanging baskets with
 wooden bottoms and
 metal railing, adjustable

HA*-2 30/40 cm

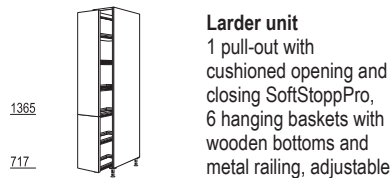

Larder unit
 1 pull-out with
 cushioned opening and
 closing SoftStoppPro,
 6 hanging baskets with
 wooden bottoms and
 metal railing, adjustable

HDA*-2 30/40 cm

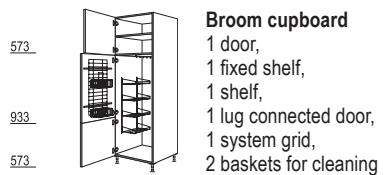

Broom cupboard
 1 door,
 1 fixed shelf,
 1 shelf,
 1 lug connected door,
 1 system grid,
 2 baskets for cleaning
 materials,
 1 system shelf,
 1 hose rack for vacuum
 cleaner,
 2 pegboards

HB*-2 40/50/60 cm

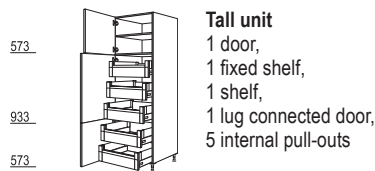

Tall unit
 1 door,
 1 fixed shelf,
 1 shelf,
 1 lug connected door,
 5 internal pull-outs

HI*-2 40/50/60 cm

Appliance housing for ovens, microwaves, steam cookers, compact appliances



Oven housing
 aperture height: 590 mm
 2 doors,
 1 fixed compensation panel,
 2 shelves

GO-2



Oven housing
 aperture height: 590 mm
 2 doors,
 1 fixed compensation panel,
 1 drawer,
 2 shelves

GOS-2

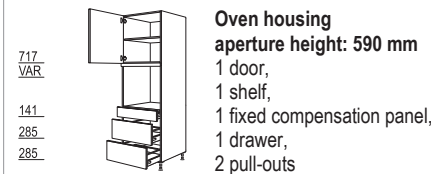

Oven housing
 aperture height: 590 mm
 1 door,
 1 shelf,
 1 fixed compensation panel,
 1 drawer,
 2 pull-outs

GOS2A-2

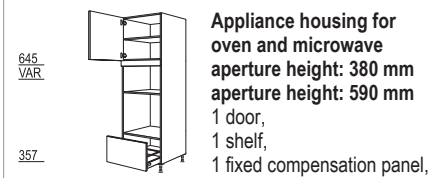

**Appliance housing for
 oven and microwave**
 aperture height: 380 mm
 aperture height: 590 mm
 1 door,
 1 shelf,
 1 fixed compensation panel,
 1 pull-out

GMO-2



**Appliance housing for
 oven and microwave with
 lifting door**
 aperture height: 370 mm
 aperture height: 590 mm
 2 doors,
 1 lifting door,
 1 fixed compensation panel,
 1 shelf

GLO-2

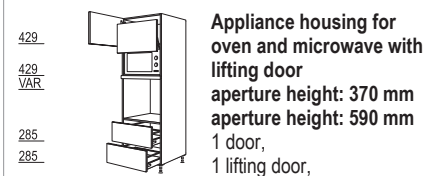

**Appliance housing for
 oven and microwave with
 lifting door**
 aperture height: 370 mm
 aperture height: 590 mm
 1 door,
 1 lifting door,
 1 fixed compensation panel,
 2 pull-outs

GLO2A-2

Appliance housings with aperture height up to 880 mm

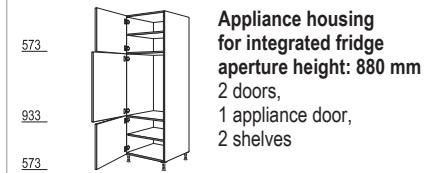

**Appliance housing
 for integrated fridge**
 aperture height: 880 mm
 2 doors,
 1 appliance door,
 2 shelves

G88-2

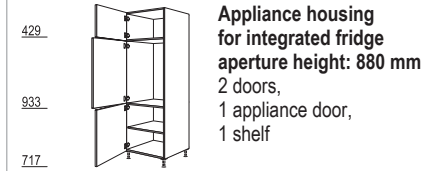

**Appliance housing
 for integrated fridge**
 aperture height: 880 mm
 2 doors,
 1 appliance door,
 1 shelf

GD88-2

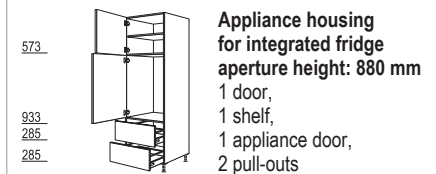

**Appliance housing
 for integrated fridge**
 aperture height: 880 mm
 1 door,
 1 shelf,
 1 appliance door,
 2 pull-outs

G88A-2

Appliance housings with aperture height up to 1230 mm

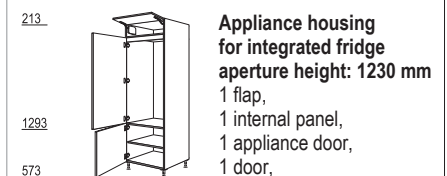

**Appliance housing
 for integrated fridge**
 aperture height: 1230 mm
 1 flap,
 1 internal panel,
 1 appliance door,
 1 door,
 1 shelf

G123-2

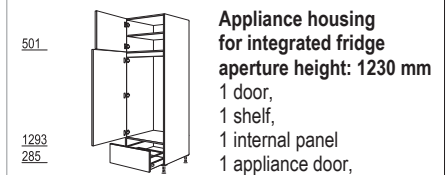

**Appliance housing
 for integrated fridge**
 aperture height: 1230 mm
 1 door,
 1 shelf,
 1 internal panel,
 1 appliance door,
 1 pull-out

G123A-2

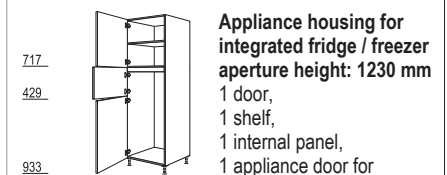

**Appliance housing for
 integrated fridge / freezer**
 aperture height: 1230 mm
 1 door,
 1 shelf,
 1 internal panel,
 1 appliance door for
 freezer compartment,
 1 appliance door for
 fridge section

G123G-2

Tall units, height 2 – 2158 / 2188 / 2238 / 2288 mm high

Carcase depth: 561 mm
 Carcase height: 2088 mm
 Plinth height: 70, 100, 150 oder 200 mm

Appliance housings with aperture height up to 1450 mm

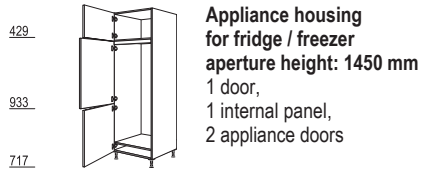

Appliance housing for fridge / freezer
 aperture height: 1450 mm
 1 door,
 1 internal panel,
 2 appliance doors

GD145-2

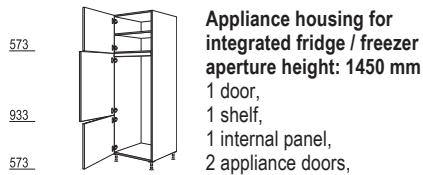

Appliance housing for integrated fridge / freezer
 aperture height: 1450 mm
 1 door,
 1 shelf,
 1 internal panel,
 2 appliance doors,

G145-2

Fillers / Cladding

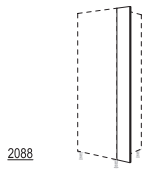

Filler
 Carcase material,
 2088 mm high,
 U-shaped seal for
 connection to wall,
 width: 230 mm

HPK20-2 20 cm

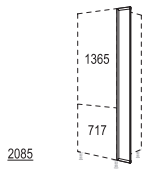

Front filler
 Continuous front material,
 width: 200 mm

HPD20-2 20 cm

Appliance housings with aperture height between 1580 - 1940 mm

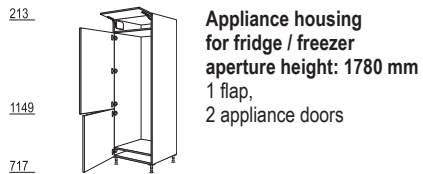

Appliance housing for fridge / freezer
 aperture height: 1780 mm
 1 flap,
 2 appliance doors

GD178-2



Tall units in XL height, height 2 XL – 2230 / 2260 / 2310 / 2360 mm high



Carcase depth: 561 mm
 Carcase height: 2160 mm
 Plinth height: 70, 100, 150 oder 200 mm

XL Tall units

573
933
645

XL Pantry unit
 3 doors,
 2 fixed shelves,
 4 shelves

H*-2X 30/40/50/60 cm

1365
789

XL Pantry unit
 2 doors,
 1 fixed shelf,
 5 shelves

HDV*-2X 30/40/50/60 cm

573
933
645

XL Larder unit
 1 pull-out with
 cushioned opening and
 closing SoftStoppPro,
 6 hanging baskets with
 wooden bottoms and
 metal railing, adjustable

HA*-2X 30/40 cm

1365
789

XL Larder unit
 1 pull-out with
 cushioned opening and
 closing SoftStoppPro,
 6 hanging baskets with
 wooden bottoms and
 metal railing, adjustable

HDA*-2X 30/40 cm

573
933
645

XL Broom cupboard
 1 door,
 1 fixed shelf,
 1 shelf,
 1 lug connected door,
 1 system grid,
 2 baskets for cleaning
 materials,
 1 system shelf,
 1 hose rack for vacuum
 cleaner,
 2 pegboards

HB*-2X 40/50/60 cm

573
933
645

XL Tall unit
 1 door,
 1 fixed shelf,
 1 shelf,
 1 lug connected door,
 5 internal pull-outs

HI*-2X 40/50/60 cm

XL Appliance housing for ovens, micro-waves, steam cookers, compact appliances

717
VAR
789

XL Oven housing
 aperture height: 590 mm
 2 doors,
 1 fixed compensation panel,
 3 shelves

GO-2X

717
VAR
141
645

XL Oven housing
 aperture height: 590 mm
 2 doors,
 1 fixed compensation panel,
 1 drawer,
 2 shelves

GOS-2X

717
VAR
141
285
357

XL Oven housing
 aperture height: 590 mm
 1 door,
 1 shelf,
 1 fixed compensation panel,
 1 drawer,
 2 pull-outs

GOS2A-2X

429
VAR
285
357

XL Appliance housing
 for oven and microwave
 aperture height: 380 mm
 aperture height: 590 mm
 1 door,
 1 fixed compensation panel,
 2 pull-outs

GMO2A-2X

429
429
VAR
645

XL Appliance housing
 for oven and microwave
 with
 lifting door
 aperture height: 370 mm
 aperture height: 590 mm
 2 doors,
 1 lifting door,
 1 fixed compensation panel,
 1 shelf

GLO-2X

429
429
VAR
285
357

XL Appliance housing
 for oven and microwave
 with
 lifting door
 aperture height: 370 mm
 aperture height: 590 mm
 1 door,
 1 lifting door,
 1 fixed compensation panel,
 2 pull-outs

GLO2A-2X

XL Appliance housings with aperture height up to 880 mm

573
933
645

XL Appliance housing
 for integrated fridge
 aperture height: 880 mm
 2 doors,
 1 appliance door,
 2 shelves

G88-2X

429
933
789

XL Appliance housing
 for integrated fridge
 aperture height: 880 mm
 2 doors,
 1 appliance door,
 2 shelves

GD88-2X

573
933
285
357

XL Appliance housing
 for integrated fridge
 aperture height: 880 mm
 1 door,
 1 shelf,
 1 appliance door,
 2 pull-outs

G88A-2X

XL Appliance housings with aperture height up to 1230 mm

213
1293
645

XL Appliance housing
 for integrated fridge
 aperture height: 1230 mm
 1 flap,
 1 internal panel,
 1 appliance door,
 1 door,
 1 shelf

G123-2X

501
1293
357

XL Appliance housing
 for integrated fridge
 aperture height: 1230 mm
 1 door,
 1 shelf,
 1 internal panel,
 1 appliance door,
 1 pull-out

G123A-2X

717
429
1005

XL Appliance housing
 for integrated fridge / freezer
 aperture height: 1230 mm
 1 door,
 1 shelf,
 1 internal panel,
 1 appliance door for
 freezer compartment,
 1 appliance door for
 fridge section

G123G-2X

Tall units in XL height, height 2 XL – 2230 / 2260 / 2310 / 2360 mm high



Carcase depth: 561 mm
 Carcase height: 2160 mm
 Plinth height: 70, 100, 150 oder 200 mm

XL Appliance housings with aperture height up to 1450 mm

429
933
789

XL Appliance housing for fridge / freezer
 aperture height: 1450 mm
 1 door,
 1 internal panel,
 2 appliance doors

GD145-2X

573
933
645

XL Appliance housing for integrated fridge / freezer
 aperture height: 1450 mm
 1 door,
 1 shelf,
 1 internal panel,
 2 appliance doors

G145-2X

XL Fillers / Cladding

2160

XL Filler
 Carcase material,
 2160 mm high,
 U-shaped seal for connection to wall,
 width: 230 mm

HPK20-2X 20 cm

2157

XL Front filler
 Continuous front material,
 width: 200 mm

HPD20-2X 20 cm

XL Appliance housings with aperture height between 1580 - 1940 mm

213
1149
789

XL Appliance housing for fridge / freezer
 aperture height: 1780 mm
 1 flap,
 2 appliance doors

GD178-2X



Tall units, height 3 – 2230 / 2260 / 2310 / 2360 mm high

Carcase depth: 561 mm
 Carcase height: 2160 mm
 Plinth height: 70, 100, 150 oder 200 mm

Tall units



Pantry unit
 3 doors,
 2 fixed shelves,
 4 shelves

H*-3 30/40/50/60 cm



Pantry unit
 2 doors,
 1 fixed shelf,
 4 shelves

HDV*-3 30/40/50/60 cm

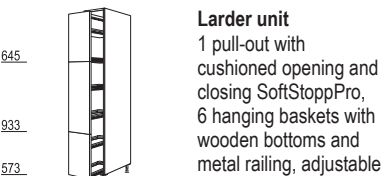

Larder unit
 1 pull-out with
 cushioned opening and
 closing SoftStoppPro,
 6 hanging baskets with
 wooden bottoms and
 metal railing, adjustable

HA*-3 30/40 cm

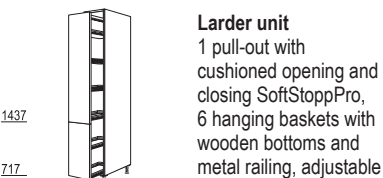

Larder unit
 1 pull-out with
 cushioned opening and
 closing SoftStoppPro,
 6 hanging baskets with
 wooden bottoms and
 metal railing, adjustable

HDA*-3 30/40 cm

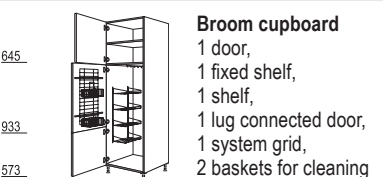

Broom cupboard
 1 door,
 1 fixed shelf,
 1 shelf,
 1 lug connected door,
 2 baskets for cleaning
 materials,
 1 system grid,
 1 system shelf,
 1 hose rack for vacuum
 cleaner,
 2 pegboards

HB*-3 40/50/60 cm

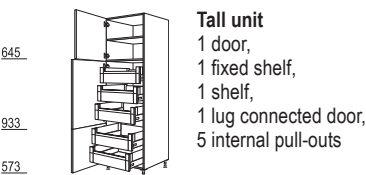

Tall unit
 1 door,
 1 fixed shelf,
 1 shelf,
 1 lug connected door,
 5 internal pull-outs

HI*-3 40/50/60 cm

Appliance housing for ovens, micro-waves, steam cookers, compact appliances



Oven housing
 aperture height: 590 mm
 2 doors,
 1 fixed compensation panel,
 3 shelves

GO-3



Oven housing
 aperture height: 590 mm
 2 doors,
 1 fixed compensation panel,
 1 drawer,
 3 shelves

GOS-3

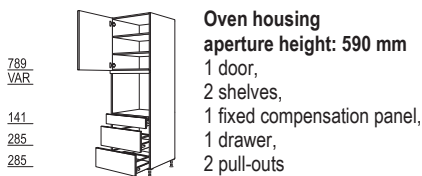

Oven housing
 aperture height: 590 mm
 1 door,
 2 shelves,
 1 fixed compensation panel,
 1 drawer,
 2 pull-outs

GOS2A-3

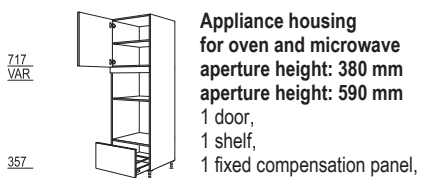

Appliance housing
 for oven and microwave
 aperture height: 380 mm
 aperture height: 590 mm
 1 door,
 1 shelf,
 1 fixed compensation panel,
 1 pull-out

GMO-3



Appliance housing for
 oven and microwave with
 lifting door
 aperture height: 370 mm
 aperture height: 590 mm
 2 doors,
 1 lifting door,
 1 fixed compensation panel,
 2 shelves

GLO-3

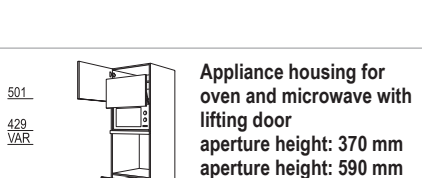

Appliance housing for
 oven and microwave with
 lifting door
 aperture height: 370 mm
 aperture height: 590 mm
 1 door,
 1 shelf,
 1 lifting door,
 1 fixed compensation panel,
 2 pull-outs

GLO2A-3

Appliance housings with aperture height up to 880 mm

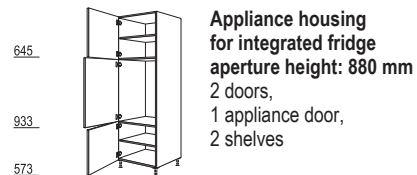

Appliance housing
 for integrated fridge
 aperture height: 880 mm
 2 doors,
 1 appliance door,
 2 shelves

G88-3

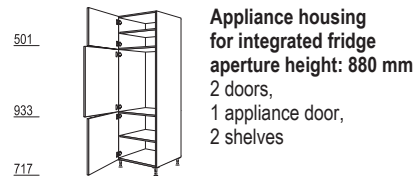

Appliance housing
 for integrated fridge
 aperture height: 880 mm
 2 doors,
 1 appliance door,
 2 shelves

GD88-3

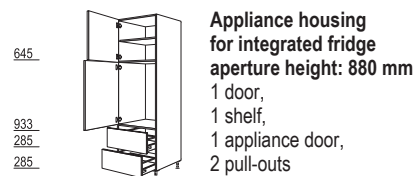

Appliance housing
 for integrated fridge
 aperture height: 880 mm
 1 door,
 1 shelf,
 1 appliance door,
 2 pull-outs

G88A-3

Appliance housings with aperture height up to 1230 mm

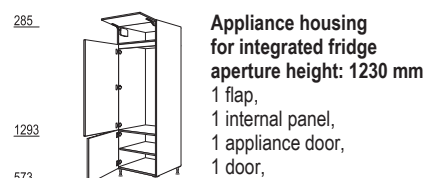

Appliance housing
 for integrated fridge
 aperture height: 1230 mm
 1 flap,
 1 internal panel,
 1 appliance door,
 1 door,
 1 shelf

G123-3

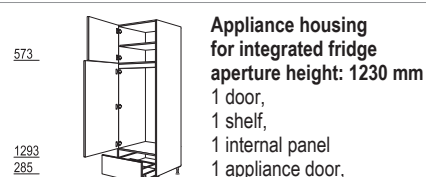

Appliance housing
 for integrated fridge
 aperture height: 1230 mm
 1 door,
 1 shelf,
 1 internal panel,
 1 appliance door,
 1 pull-out

G123A-3

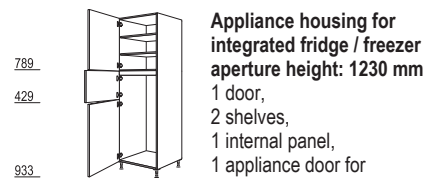

Appliance housing for
 integrated fridge / freezer
 aperture height: 1230 mm
 1 door,
 2 shelves,
 1 internal panel,
 1 appliance door for
 freezer compartment,
 1 appliance door for
 fridge section

G123G-3

Tall units, height 3 – 2230 / 2260 / 2310 / 2360 mm high

Carcase depth: 561 mm
 Carcase height: 2160 mm
 Plinth height: 70, 100, 150 oder 200 mm

Appliance housings with aperture height up to 1450 mm

501
933
717



**Appliance housing for fridge / freezer
aperture height: 1450 mm**
 1 door,
 1 shelf,
 1 internal panel,
 2 appliance doors

GD145-3

645
933
573



**Appliance housing for integrated fridge / freezer
aperture height: 1450 mm**
 1 door,
 1 shelf,
 1 internal panel,
 2 appliance doors,

G145-3

Appliance housings with aperture height between 1580 - 1940 mm

285
1149
717



**Appliance housing for fridge / freezer
aperture height: 1780 mm**
 1 flap,
 2 appliance doors

GD178-3

Fillers / Cladding

2160

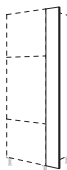

Filler
 Carcase material,
 2160 mm high,
 U-shaped seal for
 connection to wall,
 width: 230 mm

HPK20-3 20 cm

2157

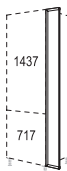

Front filler
 Continuous front material,
 width: 200 mm

HPD20-3 20 cm



Tall units in XL height, height 3 XL – 2302 / 2332 / 2382 / 2432 mm high



Carcase depth: 561 mm
 Carcase height: 2232 mm
 Plinth height: 70, 100, 150 oder 200 mm

XL Tall units



XL Pantry unit
 3 doors,
 2 fixed shelves,
 4 shelves

H*-3X 30/40/50/60 cm



XL Pantry unit
 2 doors,
 1 fixed shelf,
 5 shelves

HDV*-3X 30/40/50/60 cm

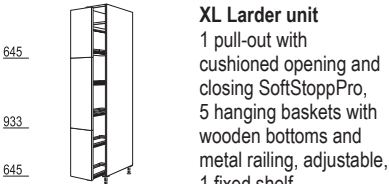

XL Larder unit
 1 pull-out with
 cushioned opening and
 closing SoftStoppPro,
 5 hanging baskets with
 wooden bottoms and
 metal railing, adjustable,
 1 fixed shelf

HA*-3X 30/40 cm

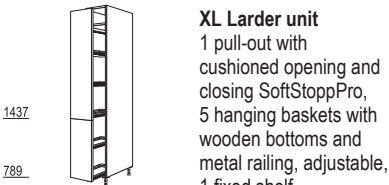

XL Larder unit
 1 pull-out with
 cushioned opening and
 closing SoftStoppPro,
 5 hanging baskets with
 wooden bottoms and
 metal railing, adjustable,
 1 fixed shelf

HDA*-3X 30/40 cm



XL Broom cupboard
 1 door,
 1 fixed shelf,
 1 shelf,
 1 lug connected door,
 1 system grid,
 2 baskets for cleaning
 materials,
 1 system shelf,
 1 hose rack for vacuum
 cleaner,
 2 pegboards

HB*-3X 40/50/60 cm

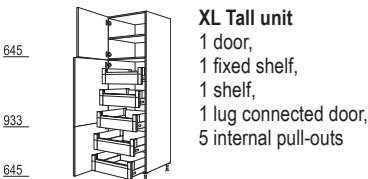

XL Tall unit
 1 door,
 1 fixed shelf,
 1 shelf,
 1 lug connected door,
 5 internal pull-outs

HI*-3X 40/50/60 cm

XL Appliance housing for ovens, micro- waves, steam cookers, compact appliances



XL Oven housing
 aperture height: 590 mm
 2 doors,
 1 fixed compensation panel,
 4 shelves

GO-3X



XL Oven housing
 aperture height: 590 mm
 2 doors,
 1 fixed compensation panel,
 1 drawer,
 3 shelves

GOS-3X

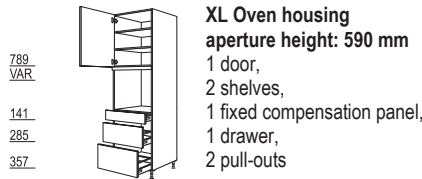

XL Oven housing
 aperture height: 590 mm
 1 door,
 2 shelves,
 1 fixed compensation panel,
 1 drawer,
 2 pull-outs

GOS2A-3X



XL Appliance housing
 for oven and microwave
 aperture height: 380 mm
 aperture height: 590 mm
 1 door,
 1 shelf,
 1 fixed compensation panel,
 1 pull-out

GMO-3X



XL Appliance housing
 for oven and microwave with
 lifting door
 aperture height: 370 mm
 aperture height: 590 mm
 2 doors,
 1 lifting door,
 1 fixed compensation panel,
 2 shelves

GLO-3X

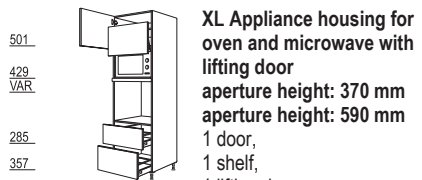

XL Appliance housing
 for oven and microwave with
 lifting door
 aperture height: 370 mm
 aperture height: 590 mm
 1 door,
 1 shelf,
 1 lifting door,
 1 fixed compensation panel,
 2 pull-outs

GLO2A-3X

XL Appliance housings with aperture height up to 880 mm



XL Appliance housing
 for integrated fridge
 aperture height: 880 mm
 2 doors,
 1 appliance door,
 2 shelves

G88-3X

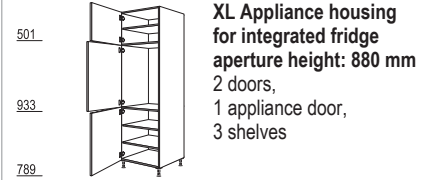

XL Appliance housing
 for integrated fridge
 aperture height: 880 mm
 2 doors,
 1 appliance door,
 3 shelves

GD88-3X

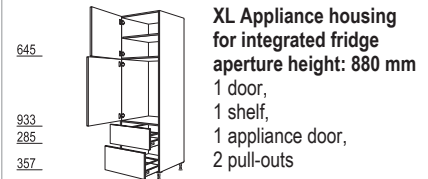

XL Appliance housing
 for integrated fridge
 aperture height: 880 mm
 1 door,
 1 shelf,
 1 appliance door,
 2 pull-outs

G88A-3X

XL Appliance housings with aperture height up to 1230 mm

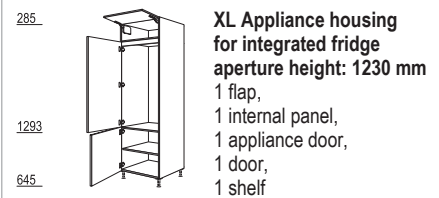

XL Appliance housing
 for integrated fridge
 aperture height: 1230 mm
 1 flap,
 1 internal panel,
 1 appliance door,
 1 door,
 1 shelf

G123-3X

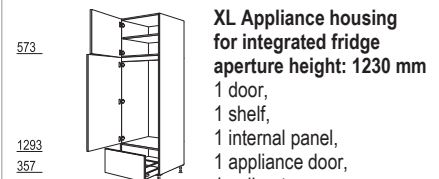

XL Appliance housing
 for integrated fridge
 aperture height: 1230 mm
 1 door,
 1 shelf,
 1 internal panel,
 1 appliance door,
 1 pull-out

G123A-3X

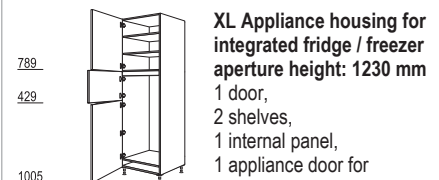

XL Appliance housing
 for integrated fridge / freezer
 aperture height: 1230 mm
 1 door,
 2 shelves,
 1 internal panel,
 1 appliance door for
 freezer compartment,
 1 appliance door for
 fridge section

G123G-3X

Tall units in XL height, height 3 XL – 2302 / 2332 / 2382 / 2432 mm high



Carcase depth: 561 mm
 Carcase height: 2232 mm
 Plinth height: 70, 100, 150 oder 200 mm

XL Appliance housings with aperture height up to 1450 mm

501
933
789

XL Appliance housing for fridge / freezer
 aperture height: 1450 mm
 1 door,
 1 shelf,
 1 internal panel,
 2 appliance doors

GD145-3X

645
933
645

XL Appliance housing for integrated fridge / freezer
 aperture height: 1450 mm
 1 door,
 1 shelf,
 1 internal panel,
 2 appliance doors,

G145-3X

XL Fillers / Cladding

2232

XL Filler
 Carcase material,
 2232 mm high,
 U-shaped seal for connection to wall,
 width: 230 mm

HPK20-3X 20 cm

1437
789
2229

XL Front filler
 Continuous front material,
 width: 200 mm

HPD20-3X 20 cm

XL Appliance housings with aperture height between 1580 - 1940 mm

1437
789





XL Appliance housing for fridge / freezer
 aperture height:
 1580 - 1940 mm
 2 appliance doors

GD194-3X





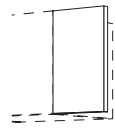
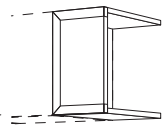

Wall units 360 mm high

Carcase depth: 350 mm
Carcase height: 360 mm

Wall units 360 mm high		Wall units 360 mm high		Fillers	
 <p>Wall unit 1 door</p> <p>W*-36 45/50/60 cm</p>	 <p>Wall unit with glass doors Square 1 aluminium framed flap, opening angle 107°, handleless version with wall unit bottom shelf with attached profile strip in stainless steel appearance</p> <p>WKSQ*-36 50/60/80/90/100/120 cm</p>	 <p>Filler Carcase material, 360 mm high, U-shaped seal for connection to wall, width: 100 mm / 200 mm</p> <p>WPK*-36 10/20 cm</p>	 <p>Front filler Continuous front material, 2 shelves top and bottom, 1 wall unit side panel: 350 mm deep, width: 200 mm</p> <p>WPD20-36 20 cm</p>		
 <p>Wall unit with flap door 1 flap, opening angle 107°</p> <p>WK*-36 45/50/60/80/90/100/120 cm</p>	<p>Available in: No. 321 Aluminium framed front in stainless steel appearance with 02 Matt glass No. 308 Aluminium framed front in stainless steel appearance with 035 Grey glass No. 329 Aluminium framed front in Black with 39 Black glass</p>				
 <p>Wall unit with framed glass flap door 1 framed glass flap door, clear glass No. 01, opening angle 107°, glass variants against surcharge: no. 02 / 39</p> <p>WKG*-36 50/60/80/90/100/120 cm</p>					
<p>No image</p> <p>MP-GW</p>	<p>Surcharge for different glass choice for glass variants: No. 02 Matt glass No. 39 Black glass</p>				

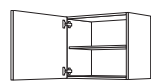
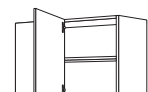
Wall units 576 mm high

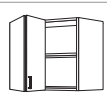
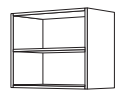
Carcase depth: 350 mm
Carcase height: 576 mm

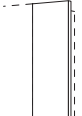
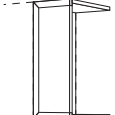
Wall units 576 mm high		Wall units 576 mm high		Wall units 576 mm high	
 <p>Wall unit 1 door, 1 shelf</p> <p>W*-58 20/30/35/40/45/50/60 cm</p>	 <p>Corner wall unit 1 door, 1 angle filler, 1 shelf <u>Carcase widths:</u> 600, 782, 882 mm</p> <p>WE60-20-58 WE80-35-58 WE90-45-58</p> <p><u>Planning dimensions (variable):</u> 450 (390 - 500) x ... WE60-20: ...650 (630 - 700) mm WE80-35: ...800 (790 - 850) mm WE90-45: ...900 (890 - 950) mm</p>	 <p>Wall unit as bottle rack 3 fixed shelves, side depth: 371 mm</p> <p>WRF15-58 15 cm</p>			
 <p>Wall unit 1 folding door with slide mechanism, 1 shelf</p> <p>WFT60-58 60 cm</p>	 <p>Open shelf wall unit 1 fixed shelf, side depth: 371 mm</p> <p>WR*-58 15/20/30/40/45/50/60 cm</p>				
 <p>Wall unit for microwave 1 aperture depending on appliance height, 1 flap as niche compensation</p> <p>WM*-58 50/60 cm</p>					
		 <p>Filler Carcase material, 576 mm high, U-shaped seal for connection to wall, width: 100 mm / 200 mm</p> <p>WPK*-58 10/20 cm</p>			
		 <p>Front filler Continuous front material, 2 shelves top and bottom, 1 wall unit side panel: 350 mm deep, width: 200 mm</p> <p>WPD20-58 20 cm</p>			

Wall units, height 1 – 720 mm high

Carcase depth: 350 mm
Carcase height: 720 mm

Wall units 720 mm high



717

Wall unit
1 door,
2 shelves

W*-1

20/25/30/35/40/45/50/55/60 cm

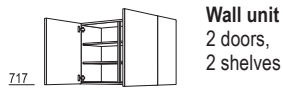

717

Wall unit
2 doors,
2 shelves

W2T-1 60 cm

W*-1 80/90/100 cm



717

Wall unit
2 doors hinged
parallel,
2 shelves

W2TP*-1

80/90/100 cm

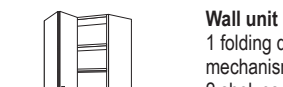

717

Wall unit
1 folding door with slide
mechanism,
2 shelves

WFT60-1

60 cm



717

**Wall unit,
framed glass door**
1 door,
clear glass No. 01,
2 glass shelves,
glass variants against
surcharge: no. 02 / 39

WG*-1

45/50/60 cm



717

**Wall unit,
framed glass door**
2 doors,
clear glass No. 01,
2 glass shelves,
glass variants against
surcharge: no. 02 / 39

WG*-1

90/100 cm



357

141

**Wall unit,
segmented glass door**
1 door,
clear glass No. 01,
2 glass shelves,
glass variants against
surcharge: no. 02 / 39

WGLS*-1

45/50/60 cm

Wall units 720 mm high



357

141

**Wall unit,
segmented glass door**
2 doors,
clear glass No. 01,
2 glass shelves,
glass variants against
surcharge: no. 02 / 39

WGLS*-1

90/100 cm

No image

MP-GW

**Surcharge for different
glass choice**

for glass variants:

No. 02 Matt glass

No. 39 Black glass

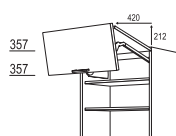

357

357

**Wall unit, folding/lifting
door**

1 folding/lifting door,
2 original fronts,
2 shelves

WFL*-1

50/60/80/90/100/120 cm

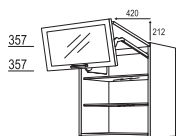

357

357

Wall unit, folding/lifting door

1 folding/lifting door,
1 top original front,
1 bottom framed glass front,
clear glass No. 01,
2 glass shelves,
glass variants against
surcharge: no. 02 / 39

WFLG*-1

50/60/80/90/100/120 cm

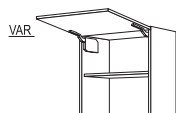

VAR

Wall unit for microwave

1 aperture depending
on appliance height,
1 flap as niche
compensation

WM*-1

50/60 cm

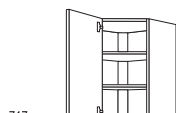

717

**Corner wall unit,
diagonal**

1 door: 394 mm wide,
opening angle 90°,
2 shelves,
Planning dimensions:
650 x 650 mm

WED65-1

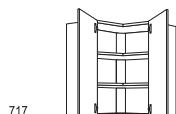

717

Corner wall unit

2 doors
with 165° hinges,
2 shelves,
hinged side = first
door to be opened

WE*-1

60/65/80/90 cm

Wall units 720 mm high



717

Corner wall unit

1 door,
1 angle filler,
2 shelves
Carcase widths:
600, 782, 882 mm

WE60-20-1

WE80-35-1

WE90-45-1

Planning dimensions
(variable):

450 (390 - 500) x ...

WE60-20: ...650 (630 - 700) mm

WE80-35: ...800 (790 - 850) mm

WE90-45: ...900 (890 - 950) mm



WR*-1

15/20/30/40/45/50/60 cm

Open shelf wall unit

2 fixed shelves,
side depth: 371 mm



WRF15-1

15 cm

Wall unit as bottle rack

4 fixed shelves,
side depth: 371 mm

Fillers



WPK*-1

10/20 cm

Filler

Carcase material,
720 mm high,
U-shaped seal for
connection to wall,
width: 100 mm / 200 mm

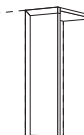

WPD20-1











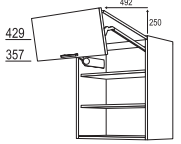

20 cm

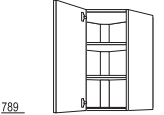
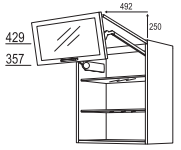
Front filler

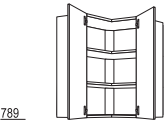
Continuous front material,
2 shelves top and bottom,
1 wall unit side panel:
350 mm deep,
width: 200 mm

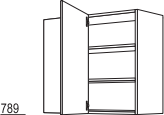
Wall units, height 2 – 792 mm high

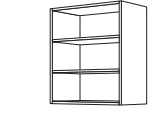
Carcase depth: 350 mm
Carcase height: 792 mm

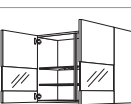
Wall units 792 mm high		Wall units 792 mm high		Wall units 792 mm high	
	Wall unit 1 door, 2 shelves		Wall unit for microwave 1 aperture depending on appliance height, 1 flap as niche compensation		Wall unit, folding/lifting door 1 folding/lifting door, 2 original fronts, 2 shelves
789	W*-2 20/25/30/35/40/45/50/55/60 cm	VAR	WM*-2 50/60 cm	429 357	WFL*-2 50/60/80/90/100/120 cm
	Wall unit 2 doors, 2 shelves		Corner wall unit, diagonal 1 door: 394 mm wide, opening angle 90°, 2 shelves, Planning dimensions: 650 x 650 mm		Wall unit, folding/lifting door 1 folding/lifting door, 1 top original front, 1 bottom framed glass front, clear glass No. 01, 2 glass shelves, glass variants against surcharge: no. 02 / 39
789	W2T*-2 60 cm W*-2 80/90/100 cm	789	WED65-2	429 357	WFLG*-2 50/60/80/90/100/120 cm
	Wall unit 2 doors hinged parallel, 2 shelves		Corner wall unit 2 doors with 165° hinges, 2 shelves, hinged side = first door to be opened		
789	W2TP*-2 80/90/100 cm	789	WE*-2 60/65/80/90 cm		
	Wall unit 1 folding door with slide mechanism, 2 shelves		Corner wall unit 1 door, 1 angle filler, 2 shelves <u>Carcase widths:</u> 600, 782, 882 mm		
789	WFT60-2 60 cm	789	WE60-20-2 WE80-35-2 WE90-45-2		
	Wall unit, framed glass door 1 door, clear glass No. 01, 2 glass shelves, glass variants against surcharge: no. 02 / 39		<u>Planning dimensions</u> (variable): 450 (390 - 500) x ... WE60-20: ...650 (630 - 700) mm WE80-35: ...800 (790 - 850) mm WE90-45: ...900 (890 - 950) mm		
789	WG*-2 45/50/60 cm				
	Wall unit, framed glass door 2 doors, clear glass No. 01, 2 glass shelves, glass variants against surcharge: no. 02 / 39		Open shelf wall unit 2 fixed shelves, side depth: 371 mm		
789	WG*-2 90/100 cm		WR*-2 15/20/30/40/45/50/60 cm		
	Wall unit, segmented glass door 1 door, clear glass No. 01, 2 glass shelves, glass variants against surcharge: no. 02 / 39		Wall unit as bottle rack 4 fixed shelves, side depth: 371 mm		
429 141	WGLS*-2 45/50/60 cm		WRF15-2 15 cm		
	Wall unit, segmented glass door 2 doors, clear glass No. 01, 2 glass shelves, glass variants against surcharge: no. 02 / 39				
429 141	WGLS*-2 90/100 cm				
No image	Surcharge for different glass choice for glass variants: No. 02 Matt glass No. 39 Black glass				
MP-GW					

Fillers

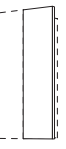
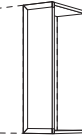
	Filler Carcase material, 792 mm high, U-shaped seal for connection to wall, width: 100 mm / 200 mm
789	WPK*-2 10/20 cm
	Front filler Continuous front material, 2 shelves top and bottom, 1 wall unit side panel: 350 mm deep, width: 200 mm
789	WPD20-2 20 cm

Wall units, height 3 – 864 mm high

Carcase depth: 350 mm
Carcase height: 864 mm

Wall units 864 mm high



Wall unit
1 door,
2 shelves

861
W*⁻3 20/25/30/35/40/45/50/55/60 cm

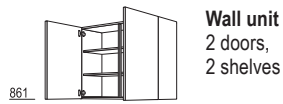

Wall unit
2 doors,
2 shelves

861
W2T*⁻3 60 cm
W*⁻3 80/90/100 cm



Wall unit
2 doors hinged
parallel,
2 shelves

861
W2TP*⁻3
80/90/100 cm

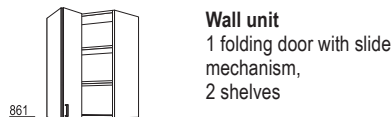

Wall unit
1 folding door with slide
mechanism,
2 shelves

861
WFT60-3
60 cm



**Wall unit,
framed glass door**
1 door,
clear glass No. 01,
2 glass shelves,
glass variants against
surcharge: no. 02 / 39

861
WG*⁻3
45/50/60 cm



**Wall unit,
framed glass door**
2 doors,
clear glass No. 01,
2 glass shelves,
glass variants against
surcharge: no. 02 / 39

861
WG*⁻3
90/100 cm

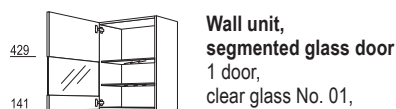

**Wall unit,
segmented glass door**
1 door,
clear glass No. 01,
2 glass shelves,
glass variants against
surcharge: no. 02 / 39

429
141
WGLS*⁻3
45/50/60 cm

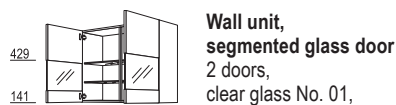

**Wall unit,
segmented glass door**
2 doors,
clear glass No. 01,
2 glass shelves,
glass variants against
surcharge: no. 02 / 39

429
141
WGLS*⁻3
90/100 cm

No image
**Surcharge for different
glass choice**
for glass variants:
No. 02 Matt glass
No. 39 Black glass

MP-GW

Wall units 864 mm high

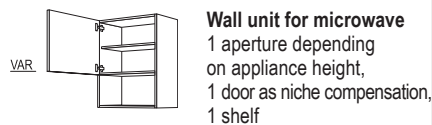

Wall unit for microwave
1 aperture depending
on appliance height,
1 door as niche compensation,
1 shelf

VAR
WM*⁻3
50/60 cm

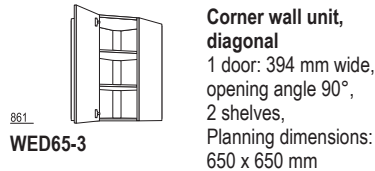

**Corner wall unit,
diagonal**
1 door: 394 mm wide,
opening angle 90°,
2 shelves,
Planning dimensions:
650 x 650 mm

861
WED65-3

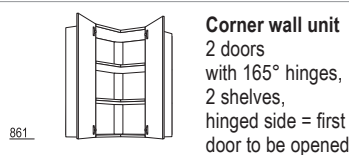

Corner wall unit
2 doors
with 165° hinges,
2 shelves,
hinged side = first
door to be opened

861
WE*⁻3
60/65/80/90 cm

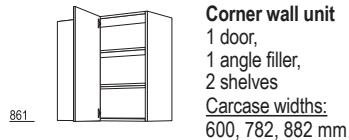

Corner wall unit
1 door,
1 angle filler,
2 shelves
Carcase widths:
600, 782, 882 mm

861
WE60-20-3
WE80-35-3
WE90-45-3

Planning dimensions
(variable):
450 (390 - 500) x ...
WE60-20: ...650 (630 - 700) mm
WE80-35: ...800 (790 - 850) mm
WE90-45: ...900 (890 - 950) mm

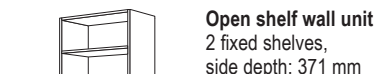

Open shelf wall unit
2 fixed shelves,
side depth: 371 mm

861
WR*⁻3
15/20/30/40/45/50/60 cm



Wall unit as bottle rack
5 fixed shelves,
side depth: 371 mm,
width: 150 mm

861
WR15-3
15 cm

Wall units for cooker hoods

Wall units for cooker hoods

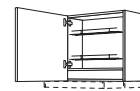

**Wall unit for
slimline cooker hoods**
internal panel,
metal grids,
80 mm deep,
the number of metal grids
depends on the built-in
dimensions of the cooker
hood

WDAF60-58 60 cm height: 576 mm

WDAF60-1 60 cm height: 720 mm

WDAF60-2 60 cm height: 792 mm

WDAF60-3 60 cm height: 864 mm

Bridging shelf

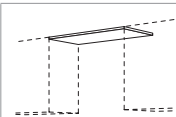

**Bridging shelf in
carcass material**
laminated on both faces in
the same colour,
16 mm thick,
350 mm deep,
with edging material on
3 sides,
for fitting between wall units
or as a window bridging.
Price per running 100 mm,
invoiced per started 100 mm.
Width: 250 - 2580 mm

WZB260

WZB60

Bridging shelf in carcass
material as above,
however 600 mm wide

Fillers

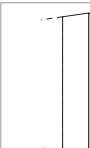

Filler
Carcass material,
864 mm high,
U-shaped seal for
connection to wall,
width: 100 mm / 200 mm

WPK*⁻3
10/20 cm

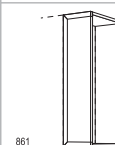

Front filler
Continuous front material,
2 shelves top and bottom,
1 wall unit side panel:
350 mm deep,
width: 200 mm

861
WPD20-3
20 cm

Accessories

Plastic cutlery trays and pull-out organisers



Cutlery tray Trend
grey, height: 43 mm,
fits drawer depth of 500 mm,
side depth: 561 mm

BE*
30/40/45/50/60/80/
90/100/120 cm

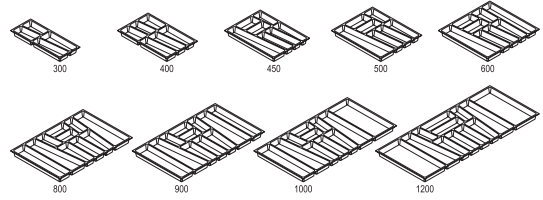

BE* -46
45/50/60/80/90/
100/120 cm

as above, however for drawer depth 400 mm,
side depth: 461 mm

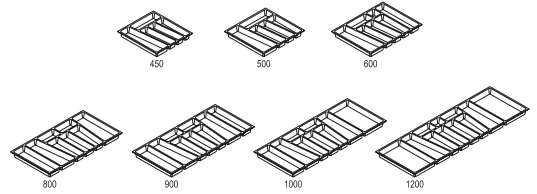

Cutlery tray Move
silver-grey, with dividers for customisable divisions,
height: 47 mm,
fits drawer depth of 500 mm,
side depth: 561 mm

BE* M
30/40/45/50/60/80/
90/100/120 cm

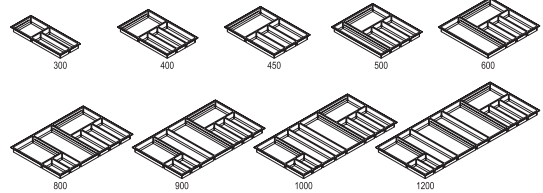

BE* -46 M
30/40/45/50/60/80/
90/100/120 cm

as above, however for drawer depth 400 mm,
side depth: 461 mm

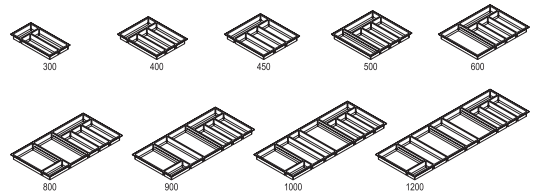

Universal organiser
Alu profile with 4 dividers for individualised divisions, height: 125 mm, fits pull-out depth of 500 mm,
side depth: 561 mm,
1 alu profile of 600 mm width,
2 alu profiles of 800 up to 900 mm width,
3 alu profiles of 1000 up to 1200 mm width

AUO 56

Please order the correct number for the unit width!

AUO 46

as above, however for pull-out depth 400 mm,
side depth: 461 mm



Cutlery tray Concept
Non-slip soft touch surface,
anthracite, height: 52 mm, fits drawer depth of 500 mm,
side depth: 561 mm

BE* C
30/40/45/50/60/80/
90/100/120 cm

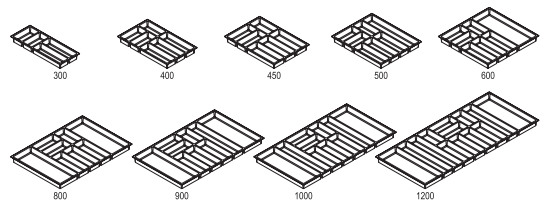

Pull-out organisation concept
Non-slip soft touch surface,
anthracite, height: 100 mm, fits pull-out depth of 500 mm,
side depth: 561 mm

AO* C
60/80/90/100/120 cm

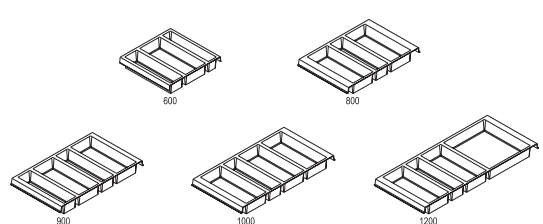

Accessories

Plastic cutlery trays and pull-out organisers



Cutlery tray black edition
Non-slip soft touch surface,
black, height: 52 mm,
fits drawer depth 500 mm,
side depth: 561 mm

BE* BE
30/40/45/50/60/80/
90/100/120 cm

black
edition

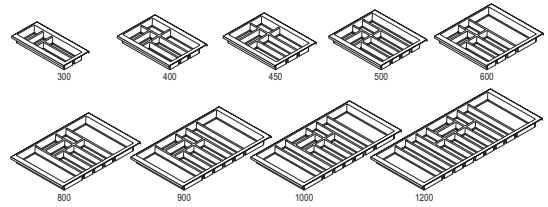

Black ash cutlery trays and pull-out organisers

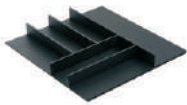

Black ash wood cutlery tray
solid ash wood, stained black,
height: 56 mm, fits drawer depth of 500 mm,
side depth: 561 mm

BE* N
30/40/45/50/60/80/
90/100/120 cm

black
edition

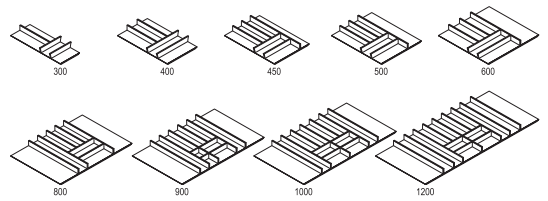

**Black ash wood cutlery tray with knife block,
storage containers and insert for spice mills and shakers**
Design in solid ash wood, stained black,
incl. 5 knives, 6 storage containers, 3 spice mills, 3 shakers,
height: 56 mm, fits drawer depth 500 mm,
side depth: 561 mm

BE-MVGS* N
80/90/100/120 cm

black
edition

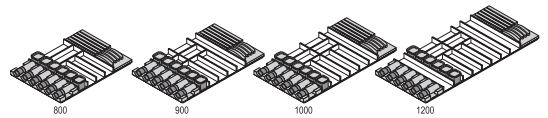

Universal organiser, black ash
with solid wood partitions for individualised divisions,
fits pull-out depth 500 mm, side depth: 561 mm,
incl. 8 solid wood partitions in ash for 600 mm width,
incl. 16 solid wood partitions in ash for 800/900/1000 mm width,
incl. 24 solid wood partitions in ash for 1200 mm width

AO* N
60/80/90/100/120 cm

black
edition



Universal organiser, black ash
with solid wood partitions for individualised divisions,
fits pull-out depth 500 mm, side depth: 561 mm,
incl. 7 solid wood partitions in ash for 600 mm width,
incl. 10 solid wood partitions in ash for 800/900/1000 mm width,
incl. 13 solid wood partitions in ash for 1200 mm width

AOS* N
60/80/90/100/120 cm

black
edition



Accessories

Beech cutlery trays and pull-out organisers



Beech wood cutlery tray
solid beech wood,
height: 56 mm, fits drawer depth of 500 mm,
side depth: 561 mm

BE* H
30/40/45/50/60/80/
90/100/120 cm

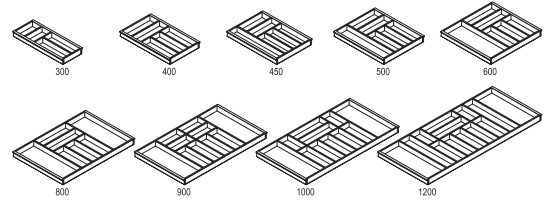

Beech wood universal organiser
with solid wood partitions for individualised divisions,
fits pull-out depth 500 mm,
side depth: 561 mm,
incl. 7 solid wood partitions in beech for 600 mm width,
incl. 10 solid wood partitions in beech for 800 / 900 / 1000 mm width,
incl. 13 solid wood partitions in beech for 1200 mm width

AOS* H
60/80/90/100/120 cm

Oak cutlery trays and pull-out organisers



Oak wooden segment cutlery tray
solid wood design in oak,
with anti-slip mat in anthracite,
height: 55 mm, segment width: 274 mm,
fits drawer depth of 500 mm,
side depth: 561 mm,
one wooden segment is delivered up to a width of 600 mm,
for widths exceeding 800 mm, two wooden segments are delivered

BEHS* E
40/45/50/60/80/90/
100/120 cm

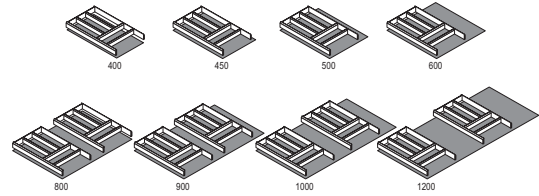

BEHS* -46 E
40/45/50/60/80/90/
100/120 cm

as above, however for drawer depth 400 mm,
side depth: 461 mm

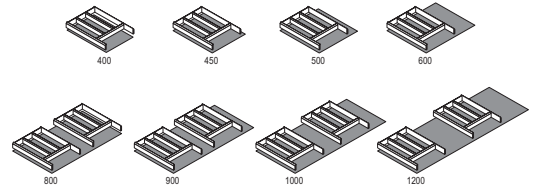

Universal organiser, oak
with solid wood partitions for individualised divisions,
fits pull-out depth 500 mm,
side depth: 561 mm,
incl. 7 solid wood partitions in oak for 600 mm width,
incl. 10 solid wood partitions in oak for 800 / 900 / 1000 mm width,
incl. 13 solid wood partitions in oak for 1200 mm width

AOS* E
60/80/90/100/120 cm



Accessories

Mounting sets



MONSET 1

Mounting set 1

consisting of:

- 1 ball siphon 1 ½" with 40 mm drain white
- 1 space-saving connector white
- 1 HT bend DN 40/87 grey
- 1 HT tube DN 40 x 250 mm grey
- 1 HT transition element DN 40 / 50 mm grey
- 1 cooker connection cable, 5 x 2.5 mm², 2000 mm long
- 2 flex hoses acc. to KTW-A, 300 mm long, 3/8" x 10 mm with union nut



MONSET 2

Mounting set 2

consisting of:

- 1 ball siphon 1 ½" with 40 mm drain white
- 1 space-saving connector white
- 1 HT bend DN 40/87 grey
- 1 HT tube DN 40 x 250 mm grey
- 1 HT transition element DN 40 / 50 mm grey
- 1 cooker connection cable, 5 x 2.5 mm², 2000 mm long
- 2 flex hoses acc. to KTW-A, 300 mm long, 3/8" x 10 mm with union nut
- 1 hose clip, 16 - 25 mm
- 1 table socket, triple, sockets - model F, with contact protection, white with 1500 mm supply line, 3 x 1.5 mm²

Accessories for sink units

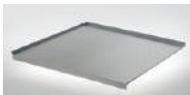

FB*

40/45/50/60/80/90/
100/120 cm

Moisture protection sheet

aluminium sheet, serrated, for sink base units, cannot be used with front pull-outs, fits only for a side depth of 561 mm

FB90: also fits corner sink units SPUE(D)90-45(-X) and NSPUE90-45(-X)

FB100: also fits corner sink units SPUE(D)100-50(-X) and NSPUE100-50(-X)



WSMS*

40/45/50/60/80/90/
100/120 cm

Waterproof mat

plastic, slate grey, for sink base units, not for use with front pull-outs, fits only side depth of 561 mm

Not possible in conjunction with hose and cable feed-through SKD or with opening support mechanism Libero AOUL.

Upstands



WAP

200/400/500 cm

Length 2000 mm

Length 4000 mm

Special length 5000 mm

Plastic upstand

Top section with sealing lips, dimensions: 25 mm high, 25 mm deep, **delivered as strand material.**

Available in all worktop décors, **also available in:**
No. 014 Stainless steel appearance

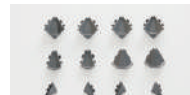

WAP-Z

WAP accessory bag

matches the plastic upstands WAPN

consisting of:

- 4 x interior corner 90°
- 2 x interior corner 135°
- 2 x exterior corner 90°
- 2 x set of end caps



WAPN

200/400/500 cm

Length 2000 mm

Length 4000 mm

Special length 5000 mm

Upstands for continuous planning with niche cladding

2-piece plastic profile with sealing lip, incl. vertical sealing profile dimensions: 25 mm high, 25 mm deep **delivered as strand material.**

Available in:

014 Stainless steel appearance, 010 Black

Bottom profile adds 4 mm to the worktop.



WAPN-Z

WAP accessory bag

matches the plastic upstands WAPN

consisting of:

- 4 x interior corner 90° / 2 x interior corner 135°
- 2 x exterior corner 90°
- 2 x set of end caps for WAPN
- 2 x set of end caps for niche cladding

Available in:

014 Stainless steel appearance, 010 Black

Dimensional drawings | Height grid

Height grid, carcase heights

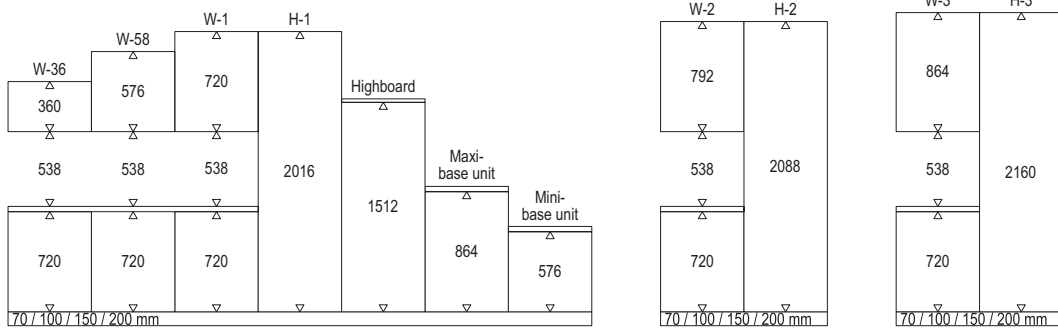

Height grid, XL carcase heights

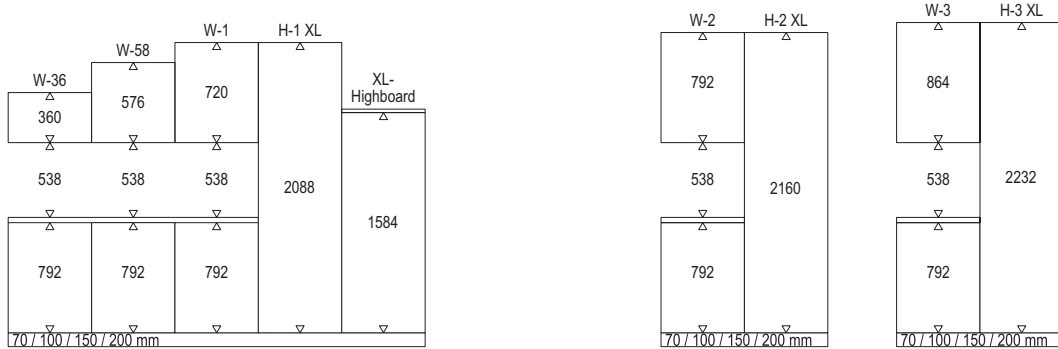

Height grid, standard and maxi door dimensions

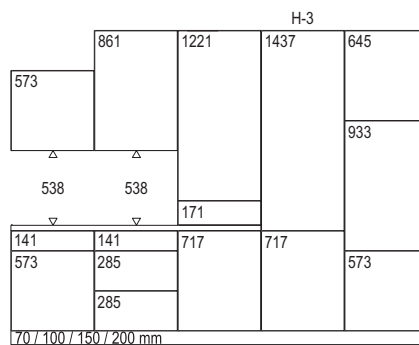
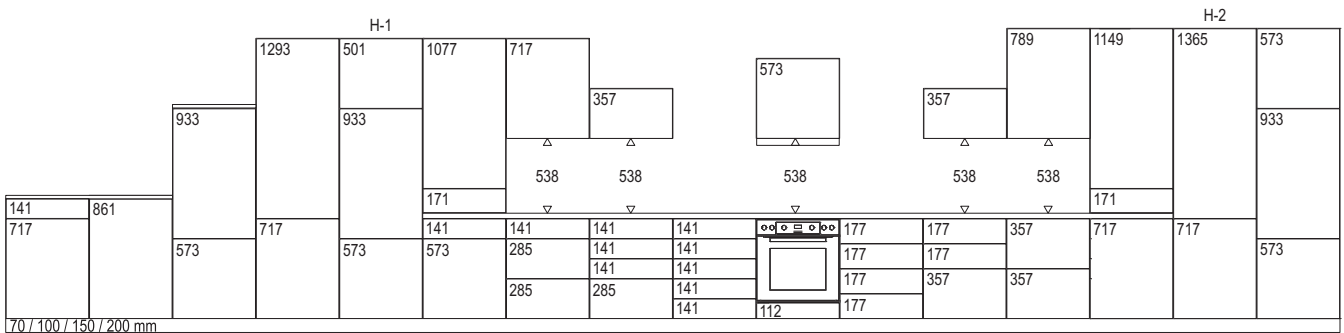

Dimensional drawings | Height grid

Height grid, XL door dimensions, Height 1

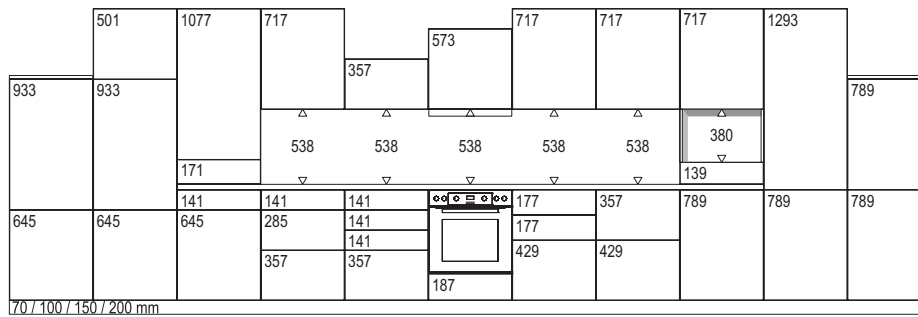

Height grid, XL door dimensions, Height 2

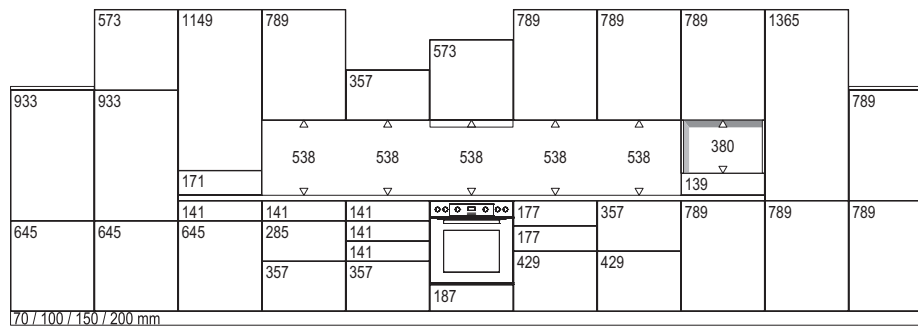

Height grid, XL door dimensions, Height 3

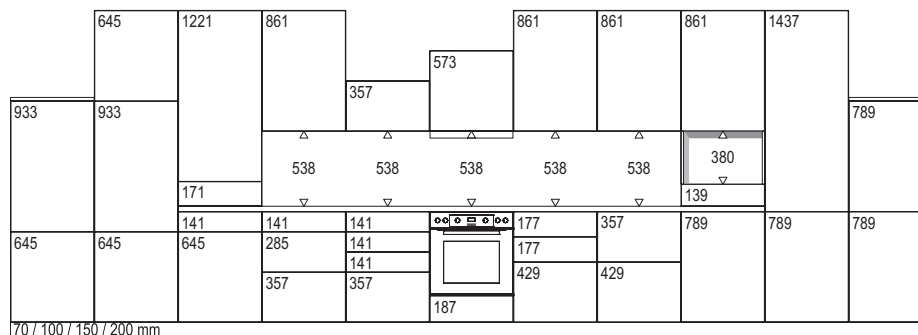

Height grid, tall units

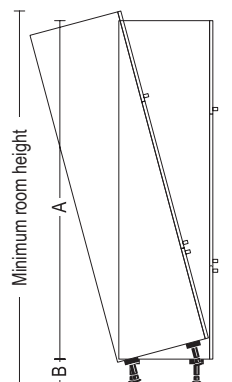

Minimum room heights

A* \ B*	70 mm	100 mm	150 mm	200 mm
2016 mm	2147 mm	2176 mm	2224 mm	2273 mm
2088 mm	2217 mm	2246 mm	2295 mm	2343 mm
2160 mm	2287 mm	2316 mm	2365 mm	2414 mm
2232 mm	2357 mm	2386 mm	2435 mm	2484 mm

A* = Tall unit height
B* = Plinth height

nobilia-Werke
J. Stickling GmbH & Co. KG
Waldstraße 53 - 57
33415 Verl
info@nobilia.de
www.nobilia.de

Kurztypenliste 2023

92707



EN