

nobilia[®]

Interior organisation

**STORAGE SPACE
WITH ME IN MIND**



PERFECTLY ORGANISE EVERYDAY LIFE

Is there anything better than a well-organised home? With intelligent interior organisation and plenty of good ideas, you can design your kitchen to be nice and tidy. Our objective: storage space with me in mind. We focus entirely on what's inside, regardless of the size of the kitchen. What's the best way to structure and optimise storage space in a large or smaller kitchen? What does a drawer need to be capable of? Are there any sustainable and hygienic options for dealing with waste and recycling? We have just the right solution for any question – and a whole host of detailed, forward-looking ideas.

Whether stylish organisation or first-class functionality, our drawers and pull-outs reflect the high quality standards of our interior organisation. Our innovative nBOX system combines premium style with maximum convenience and flexible design options. The clear, minimalist aesthetics of nBOX extend harmoniously throughout the interior of our furniture, ensuring a consistent appearance.

Discover how our diverse selection can further optimise interior organisation on a daily basis. Enjoy!

PERFECTION IN FORM AND FUNCTION

n144
the living system

Storage solutions require space and structure, which is why we plan each and every element from the very start – for a kitchen that not only looks good, but also makes processes convenient and efficient. Our grid system, the Living System, provides consistent, harmonious lines that form the visual hallmark of our kitchens, and is based on our drawer measuring 144 mm in height, which is tall enough to stow away larger kitchen utensils and slim enough to ensure an elegant design. The height of each additional unit in our range is based on this smallest of dimensions, resulting in a uniform joint pattern, as all the elements fit flawlessly together.

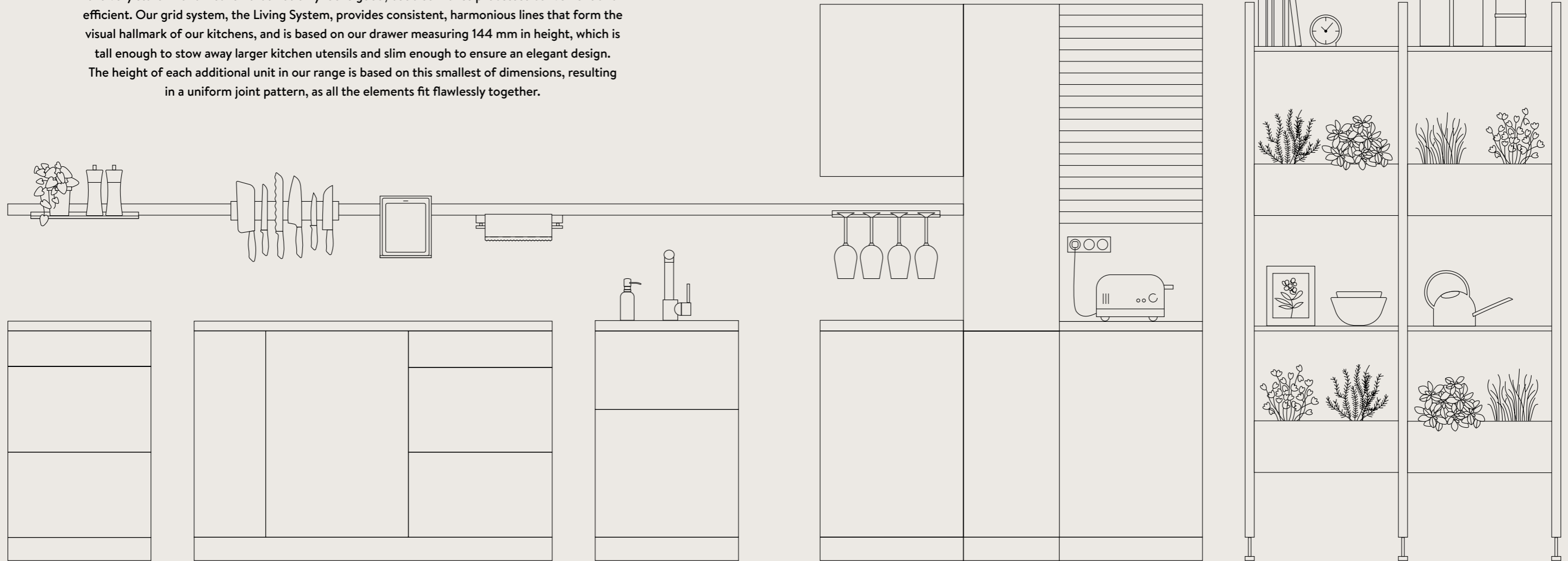

01

SYSTEMATIC ORGANISATION

Drawer and pull-out system
Cutlery trays
Universal organisers
Pull-out organisers

P. 06 – 33

02

EVERYTHING AT A GLANCE

Pull-out units
Corner unit solutions

P. 34 – 41

03

NEATLY STRUCTURED, OPTIMALLY ORGANISED

Waste separation systems
Organisation systems
for base units

P. 42 – 45

04

ALWAYS WITHIN EASY REACH

Wall unit solutions
Tall units with internal pull-outs
Larder units
Access doors

P. 46 – 53

05

ADDITIONS FOR CUSTOMISATION

Pole-mounted shelving system
Railing systems
Smart lighting systems
Practical additions

P. 54 – 70

THE RIGHT SOLUTION FOR ANY PROBLEM

Whether your kitchen is big or small, sophisticated structures are sure to simplify everyday life. Our ideas and must-haves ensure plenty of storage space even in smaller rooms. And just like that, we provide you with a whole host of new opportunities for using every last corner.



STORAGE SPACE DOWN TO THE LAST CORNER

More is possible than you might think. Niche shelves, corner unit solutions and our railing systems will work wonders for your storage space, as even the smallest of areas offer room. More about our practical additions from page 54.



BYE BYE, CHAOS!

A clear overview at a glance. The organisation systems for drawers and pull-outs keep everything tidy and where it belongs. A large selection of inserts and sets offer a suitable solution for every drawer and pull-out size – for example, as a combination of fixed and flexible dividers. All drawer and pull-out solutions are available from page 16.



NO STORAGE SPACE? NOT A PROBLEM.

Larder units can handle it all. Whether big or small, this pull-out system uses space effectively and provides convenient access to utensils and foods on both sides. Storage space that's accommodating all round. More about our tall unit solutions from page 48.



PURE DESIGN INNOVATION

For individual needs and the most discerning demands: experience the modern standard for our drawer and pull-out system with our innovative nBOX. Give your kitchen an unmistakable style with premium design, maximum convenience, state-of-the-art technology and the ultimate in design freedom.

MORE DESIGN

The nBOX impresses with its filigree, angular design and the slim drawer frame of just 10.7 millimetres. The straightforward, minimalist aesthetics are a feature of our entire pull-out system and interior in form and colour. The elegant slate grey, also reflected as an option in the cabinet interior, is perfect for a consistent design in the kitchen, bathroom and living room.

MORE COMFORT

The nBOX not only impresses with its elegant appearance but also with its convenient qualities that shine out in any room. The innovative technology, concealed beneath the drawer, provides more space inside and optimises space utilisation. Perfectly suitable for everyday use: even loaded to its impressive 70 kg total load capacity, the nBOX guarantees smooth opening and closing and safe lateral stability.



The nBOX's push-to-open system offers the perfect solution for handleless designs: effortless opening and soft, cushioned closing – pure comfort in its most beautiful form!

MORE CHOICES

The versatile nBOX adapts to your style and needs. Whether with its standard railing, or optional glass side in grey glass or as a closed pull-out box – the nBOX pull-out system opens up more design options for you to enjoy with its three different versions. Our stylish design profiles and design covers let you personalise the nBOX drawers and pull-outs even more.

ONE SYSTEM – LOTS OF DESIGN FREEDOM

Our nBOX offers you more customisation options, with three pull-out designs to choose from for your internal drawers: pull-out front with angular railing, pull-out front with grey glass and a tall pull-out box. The internal drawers and pull-outs can also be customised with a variety of front panels for a visually and functionally enhanced design. Whilst the standard panel is made from wood, optional features include an attractive glass panel and an attractive closed panel made from plastic.



Keeping an overview: our pull-outs with railing offer a perfect view of the interior. An additional option with a glass side in grey glass gives an elegant and high-quality touch to the design. Interior pull-outs with glass design panels provide even more transparency and elegance.



Coordinate the nBOX tone-on-tone or with elegant accents to perfectly match your interior.



INDIVIDUALLY REFINED

Customise the look of the nBOX drawers and pull-outs as you wish with stylish design profiles and design covers. Set accents – exclusive and extravagant bronze or natural and relaxed Sierra oak. Or go for an elegant tone-on-tone design with slate grey profiles. The covers and profiles can be inserted with a flick of the wrist and replaced at a later date.

The design covers and profiles offer additional customisation options for the drawers and pull-outs. Our design covers provide a completely new look and make it possible to customise the sides of the nBOX to suit your style or kitchen furnishings.



Small change, big impact: the design profile is a beautiful eye-catcher and gives the slate grey drawers and pull-outs a distinctly individual character.

PERFECT MATCH

The elegant premium design of the nBOX is continued in the interior of our cabinets and pull-outs with its cubic design language and slate grey colour scheme. For drawers, pull-outs, larder units or half cabinets with swivel pull-outs: every element of our range has been perfectly coordinated to create a uniform look.



Our slate grey or oak cutlery inserts and universal organiser systems blend seamlessly into the nBOX look. The interior organisation system in solid oak can be harmoniously combined with the nBOX design covers and profiles in Sierra oak to create stylish accents.





01 — SYSTEMATIC ORGANISATION

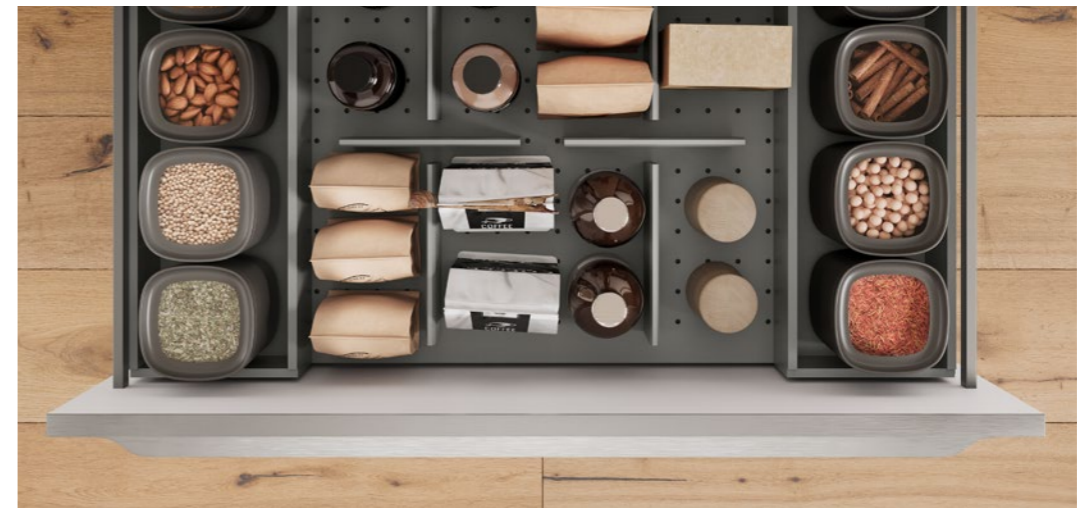

Are you tired of the chaos of typical drawers? Simply focus on what's inside. Cutlery trays and practical organisation systems can now structure the interior of cabinets and pull-outs, always taking your needs into account.



THE AESTHETIC SIDE OF ORGANISATION

Plastic or genuine wood? It's entirely up to you. Organise your drawers with a structure that meets your personal needs and reflects your everyday life. Combine your cutlery trays with the nBOX in slate grey for a tone-on-tone design – or make an elegant statement with the cutlery tray in solid oak. Our organisation elements make the best use of your kitchen. Take advantage of our versatile range of equipment elements and enjoy the perfect solution every day.



PLASTIC CUTLERY TRAYS

Easy-care design! Whether Youno or Depot, our plastic cutlery trays in slate grey are ultra practical and hygienic. The Depot cutlery tray also boasts a soft-touch finish that prevents items from sliding around., so everything stays where it belongs.



TIDY AND VISUALLY AESTHETIC CUTLERY TRAYS WITH ELEMENTS FOR CUTLERY, KNIVES, SPICES AND MORE.

CUTLERY TRAYS IN OAK

Perfectly organised, naturally. The extraordinary quality of the cutlery trays made from genuine oak stand out from the very first glance. Aesthetic, durable and robust. The cutlery tray in oak forms a stylish contrast to the nBOX in slate grey. The nBOX design cover and profile in Sierra oak complement the cutlery tray to perfection for a harmonious look.



CUTLERY TRAYS IN SLATE GREY ASH WOOD

Genuine wood in dark slate grey makes an especially elegant and exclusive impression. Does elegant tone-on-tone décor tickle your fancy? Our cutlery trays in slate grey blend visually with the nBOX for a seamless look and can be mixed and matched to perfection with the colour-coordinated storage containers.



OUR TIP

Save time and begin cooking straightaway without having to rummage around for herbs, knives, whisks and more. A place for everything and everything in its place. The drawer below the hot plate is a good example.



FOLLOWER MECHANISM FOR INTERNAL DRAWERS

Make it easier than ever to access the internal drawer. As you pull out the front pull-out, simply pull out the internal drawer at the same time. With the press of a finger, you can unlock the follower mechanism and freely move the drawer.



Depot cutlery tray with inserts for spice containers

PLASTIC

Youno cutlery tray

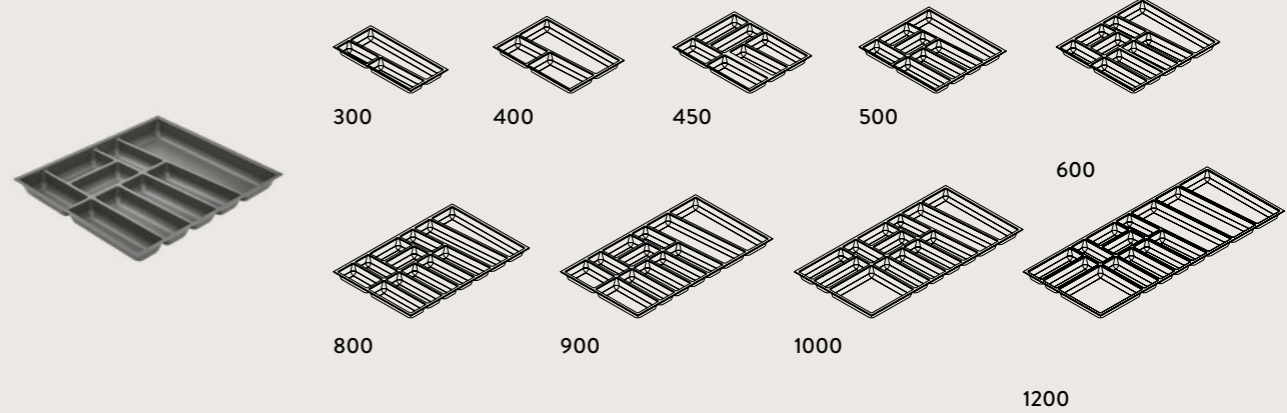

All sizes available for a drawer depth of 500 mm.
With the exception of sizes 300 and 400, also available for a drawer depth of 400 mm.

Depot cutlery tray

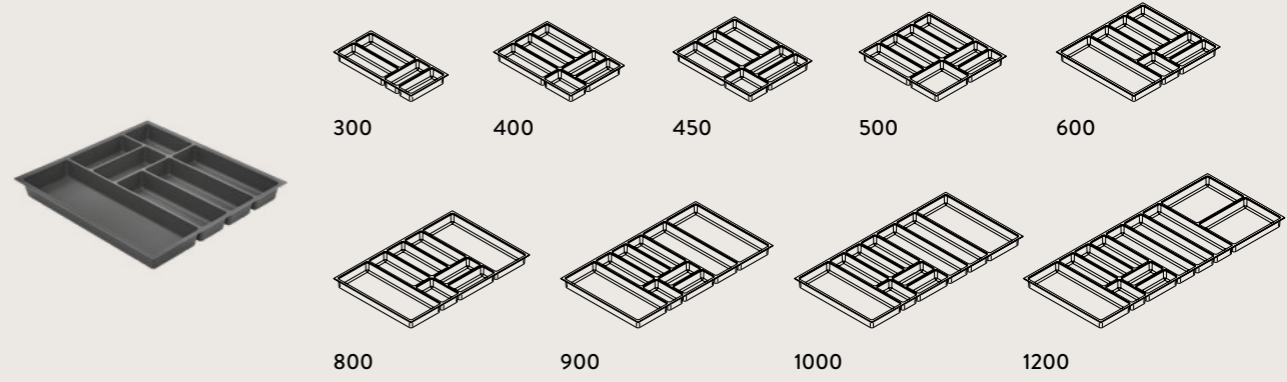

All sizes available for a drawer depth of 500 mm.
With the exception of sizes 300 and 400, also available for a drawer depth of 400 mm.

Depot module insert



Also available as a module insert for unit widths from 600 mm.
Units widths from 900 mm can accommodate two module inserts,
and unit widths from 1,200 mm three module inserts.

Equipment elements for Depot cutlery tray

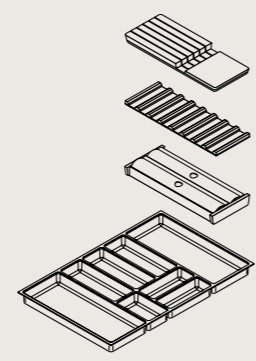

For drawer sizes of 800 mm or larger, customers can choose a cutlery tray with a knife block, an insert for spice containers or an insert for cling wrap cutter. The equipment elements are not available individually.



Oak wood cutlery tray with knife block

OAK AND SLATE GREY ASH

Equipment elements for oak and slate grey ash wood cutlery tray

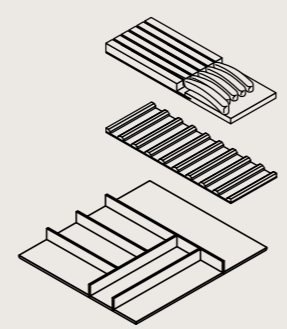

For a drawer size of 600 mm, customers can choose a cutlery tray with a knife block or inserts for spice containers. The equipment elements are not available individually.

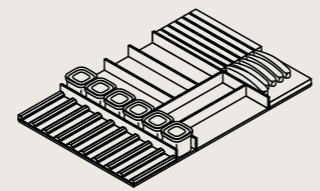

The cutlery tray is also available as a set with additional storage containers for drawer sizes of 800 mm or larger.

Oak wood cutlery tray

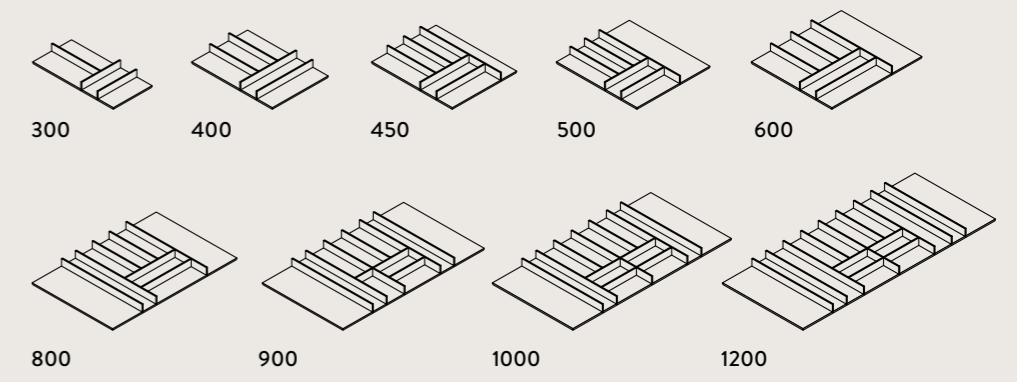

All sizes available for a drawer depth of 500 mm. With the exception of sizes 300 and 400, also available for a drawer depth of 400 mm.

Slate grey ash wood cutlery tray

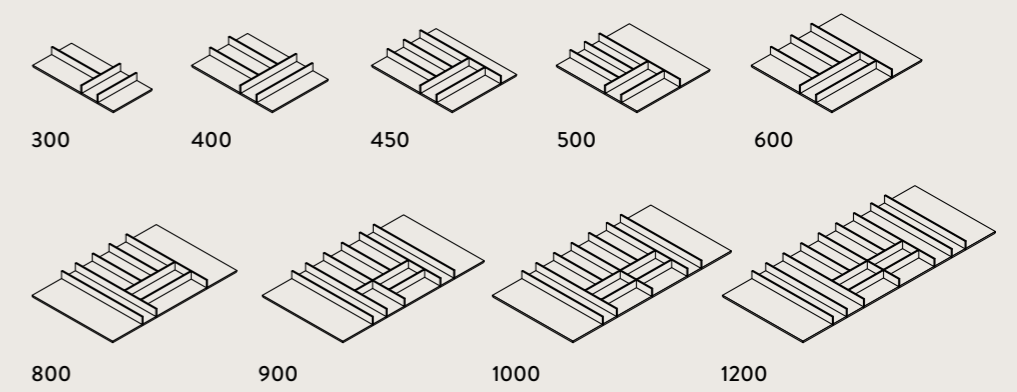
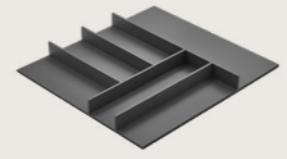

All sizes available for a drawer depth of 500 mm. With the exception of sizes 300 and 400, also available for a drawer depth of 400 mm.



FULLY CUSTOMISED: SIMPLE AND UNCOMPLICATED

The best recipe for organisation: our universal organisers offer plenty of space and are divided into compartments, offering a tidy overview at all times. Available in different variants and designs which can be adapted to meet your needs.



UNIVERSAL ORGANISERS IN BLACK ASH

Organisation that makes a statement! Our universal organisers for pull-outs feature adjustable wood partitions and pegs, allowing you to organise your storage space as you see fit. In combination with the universal organiser and the matching glazed woods such as ash, the slate grey of the nBOX radiates premium quality.



OUR TIP

Our universal organisers make it easier than ever to create clear structures that will integrate visually into your kitchen regardless of the style.



UNIVERSAL ORGANISERS IN OAK

Tidy and visually aesthetic! Containers, plates and bowls can be organised vertically in a row or stacked. Our drawers and pull-outs are not only highly robust, but also look good.



CUSTOMISE YOUR PULL-OUTS IN NO TIME WITH WOOD PARTITIONS AND PEGS



OUR TIP

Say goodbye to rattling and clanking!
Non-slip mats reduced noise and ensure
that pots and other utensils stay in place.
Our mats are suitable for a drawer depth
of 500 mm, but can also be cut to size.





Universal slate grey ash organiser with solid wood rods

OAK AND BLACK ASH

Material variants for solid wood partitions and pegs



Oak

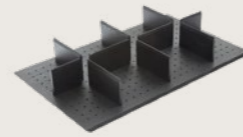

Slate grey ash

Universal organisers

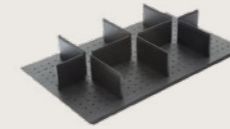

Solid wood partitions

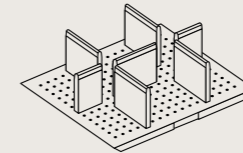

Incl. 7 partitions for 600 mm width

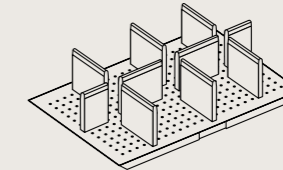

Incl. 10 partitions for 800 to 1,000 mm width

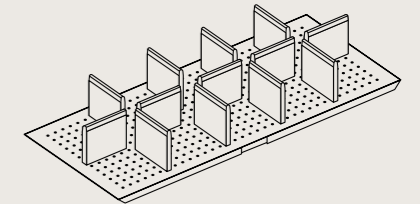

Incl. 13 partitions for 1,200 mm width



Solid wood pegs

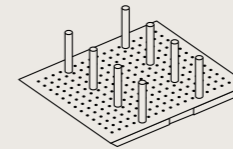

Incl. 8 pegs for 600 mm width

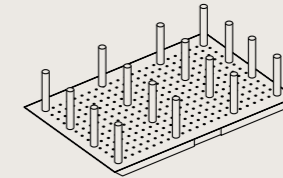

Incl. 16 pegs for 800 to 1,000 mm width

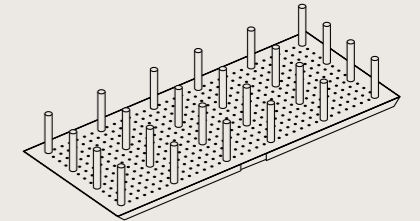

Incl. 24 pegs for 1,200 mm width

Also available as a set of 8.

Extension with storage containers



Solid wood partitions and large storage containers

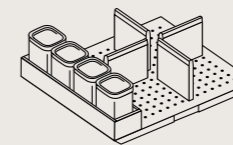

Incl. 4 partitions for 600 to 900 mm width

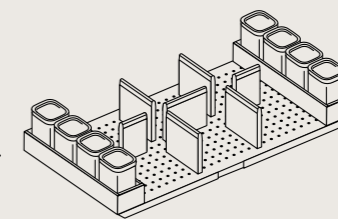

Incl. 7 partitions for 1,000 mm width

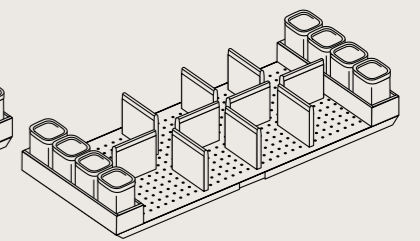

Incl. 10 partitions for 1,200 mm width

With 4 storage containers for 600 mm width.
With 8 storage containers for 800 to 1,200 mm width.

The wood insert with four storage containers is also available individually.

PRACTICAL PULL-OUTS FOR GREATER CONVENIENCE

Organise everything in a flash with the greatest convenience. Pull-outs are wonderfully functional and can even help sensibly organise storage spaces in larger kitchens – with adjustable dividers. And sometimes with a surprisingly sustainable solution, as even our Gardening Box fits perfectly into a pull-out.



SPACEFLEXX

The customisable organisation system for storage containers and kitchen utensils keeps drawers nice and tidy. Flexible dividers bring structure to every pull-out. Nothing tips over or falls out, and you can find what you need straightaway. SpaceFlexx® can be integrated into any drawer with a front width of 60 cm or more. The wonderfully versatile and flexible nesttex® Inside divider adapts specifically to the contours and size of the stored goods and can also be cleaned in the washing machine for convenience.

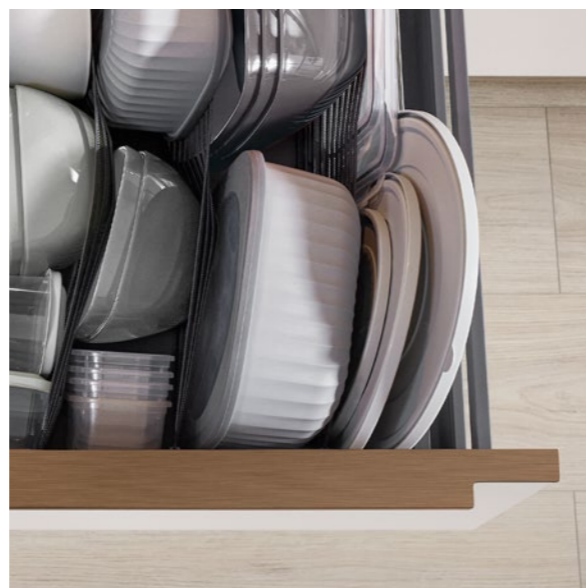

OUR TIP

The small organic garden in a drawer is a wonderful idea for people who prefer things a little greener.

The Gardening Box offers the perfect solution to grow healthy microgreens yourself. A variety of microgreens are applied to seed mats on four trays. Young, edible seedlings that are ideal for fresh and healthy nutrition.

The practical Gardening Box features grow lights and ventilation, which control the plants' day and night cycle. The plants can be harvested after 7 to 10 days – simply monitor growth with the app.

PANTRY BOX

Wonderfully stored and always within easy reach. This sturdy Pantry Box contains a shelf with drain and ventilation slots and a small carrying caddy, which is ideal for storing vegetables and baked goods and keeping them fresh. Made from tempered glass, the hygienic sliding cover also protects food when the draw is closed, offering yet another benefit.





02 — EVERYTHING AT A GLANCE



Some solutions simply make the best of everyday life in the kitchen!
Just a quick glance and the work can begin. Pull-out systems
and corner unit solutions in base units offer plenty of potential and space
for pots, bowls and anything else you'd like to have within easy reach.

SOLUTIONS THAT ACCOMMODATE YOUR NEEDS

It's so practical when the kitchen can relieve you of some of your work. Rummaging around in the cabinets is a thing of the past, now that the kitchen utensils are here to assist you. Our pull-out and corner unit systems always provide convenient access. From the swivel tablars and hanging baskets to our UBOXX organiser system, all the items in our range are perfectly coordinated in terms of their angular, minimalist design in slate grey, ensuring a holistic interior.



PULL-OUT SYSTEMS

With everything so well organised on multiple levels, you can reach food or kitchen utensils with the greatest of ease. Which you can access directly from any side regardless of where you are. The customisable organisation systems like the Junior larder pull-out with adjustable hanging baskets offer a practical solution.



OUR TIP

Systematic organisation is always a good idea. Our customisable UBOXX organiser system offers dividers and compartments in a variety of sizes and heights, so you have the space to store it all. Structure the system in a way that meets your everyday needs.



EXPLOIT CORNER SPACE WITH SWIVEL TABLARS, WHICH PROVIDE ACCESS TO POTS, PANS AND BOWLS.

EXPLOITING CORNER SPACE

There's really no need for this shape to lead a marginal existence, as it can provide unused space with real added value. Highboard or traditional solution? Add a little movement to your storage space and enjoy convenience and structure every day.





Base unit with Junior apothecary pull-out unit

FUNCTIONAL PULL-OUTS

For 150 mm width



Pull-out unit with towel rail



Pull-out unit with 2 metal baskets with non-slip mats



Pull-out unit with baking tray holder

For 300 mm width



Pull-out unit with internal drawers and removable metal bottle rack



Base unit with Junior apothecary pull-out unit and adjustable UBOXX storage system with divider for knives and chopping board holder



Base unit with Junior apothecary pull-out unit and 2 adjustable metal boxes with non-slip mats



Pull-out unit with baguette bag



Half corner unit with swivel pull-out unit

CORNER UNITS

Diagonal corner units



Diagonal carousel unit with rotary shelves and metal railing



Diagonal corner unit with shelves

Corner units



Carousel corner unit with rotary shelves and metal railing

Half corner units



Half corner unit with swivel pull-out



Half corner unit with rotary shelves

Corner highboards



Corner highboard with swivel pull-outs

All our corner units, diagonal corner units and half corner units are available with shelves.



03 — NEATLY STRUCTURED, OPTIMALLY ORGANISED



Waste is an issue in every household and, of course, in society. Our aim is as little as necessary and as effectively separated as possible. And this is precisely where we can help, with our sophisticated selection of waste separation systems for base units and sinks.

WASTE SEPARATION SYSTEMS



Neatly structured, optimally organised

Flex 21 waste separation system

Waste separation system for pull-out units



300 mm width
1x 18 litres / 1x 8 litres, 2 container lids
450 mm width
1x 18 litres / 2x 8 litres, 3 container lids
600 mm width
1x 17 litres / 2x 8 litres, 3 container lids or 2x 26 litres, 2 container lids

Recycling bin for pull-out units



300 mm width
1 recycling bin, 44 Liter

Euro-Cargo waste separation system for pull-out units



450 mm width
2x 35 litres
500 mm width
2x 35 litres
600 mm width
2x 35 litres / 2x 10 litres

Frame waste separation system for sink units



450 mm width
2x 13 litres
500 mm width
2x 16 litres
600 mm width
1x 17 litres / 2x 8 litres

Separato-K waste separation system for sink units



450 mm width
1x 18 litres / 2x 8 litres, 1 bio lid
500 mm width
1x 18 litres / 2x 8 litres
1 side organiser, 1 bio lid
600 mm width
1x 18 litres / 2x 8 litres
2 side organisers, 1 bio lid

Flex 33 waste separation system for sink units



450 mm width
2x 20 litres
500 mm width
2x 20 litres
600 mm width
2x 26 litres

Flex 21 waste separation system for sink units



600 mm width
1x 17 litres / 2x 8 litres, 3 container lids or 2x 13 litres, 2 container lids

Organisation module for Flex 21 waste separation system



The Flex 21 waste separation system is also available with an additional organisation module for unit widths from 800 mm. The bins and organisation module can be moved individually.



04 — ALWAYS WITHIN EASY REACH



Things always seem to accumulate in everyday life. You can never have enough space, which is why we've developed a versatile range of storage options in tall and wall units which not only enrich life, but also provide structure.

HIGHLY STRUCTURED TALL UNITS

They exist – space miracles that create more space than they take up. One of these is undoubtedly tall units, which can be integrated into kitchen planning in many different shapes and boast attributes that are sure to surprise the moment the door is opened.



PANTRIES

Enjoy wonderfully convenient storage space solutions with our larder unit or the Cargo pantry, which provide you with simple access to foods. Outstanding! Everything is visible at all times – you simply need to grab it.



ORGANISATION SYSTEMS

Where do you put the ironing board, the broom and cleaning equipment? We offer a diverse range of freely configurable organisation systems for tall units that allow you to stow away just about everything with ease, which is perfect when you don't have a utility room.



HOUSING FOR RAISED WASHING MACHINES

We offer you the TÜV-certified housing for built-in washing machines. Winning arguments: loading and unloading is wonderfully convenient and, thanks to special shock absorbers and a frame design, the washing machine stays exactly where it's supposed to, even during the fastest spin cycle. The stylish way to integrate a washing machine.



OUR TIP

Special holders provide space to store multiple bottle crates in a tall unit. You'll also be glad to hear that you can install up to 3 holders in a single unit, each with a capacity of up to 35 kg. A convenient solution for those who don't have a basement.

ORGANISATION SYSTEMS FOR TALL UNITS



Always within easy reach

Tall unit front with straightener throughout



Tall unit with internal pull-outs



Cargo pantry



Tall unit with larder pull-out



Tall unit for bottle crates



Tall unit with Laundry-Area laundry basket tablar



Broom and appliance cupboard



Laundry-Area organisational system



Housing for washing machine / dryer

EXPAND YOUR OPPORTUNITIES

There are plenty of options for optimal use of space behind skilfully positioned sliding and access doors and inside wall units, which also offer plenty of design options. For example, they can serve as an elegant form of storage space, connect rooms or discreetly conceal what you'd rather keep hidden.



ACCESS DOORS

An access door in a tall unit format allows you to design additional areas or rooms in the same charming look as that of your kitchen. Just close the door to conceal everything behind it. You can even hide smaller pantries and utility rooms behind access doors that visually complement your kitchen to perfection. Available in single and double-leaf designs.



SLIDING DOORS

Always a tidy impression. Integrated into the kitchen's design concept, selected areas or rooms can be cunningly concealed with large-format sliding doors.



SPICE RACK AND CANISTER INSERT

Always maintain a clear overview! The wall unit is sure to surprise with an integrated spice rack, which offers space for up to 24 spice jars. The complementary 6 canisters are perfect for noodles, flour and sugar.



OUR TIP

A good mantra: use all the space. It's often the little things that make all the difference. Take, for example, movable and ergonomic helpers, which allow you to make full use of the higher areas of the units.

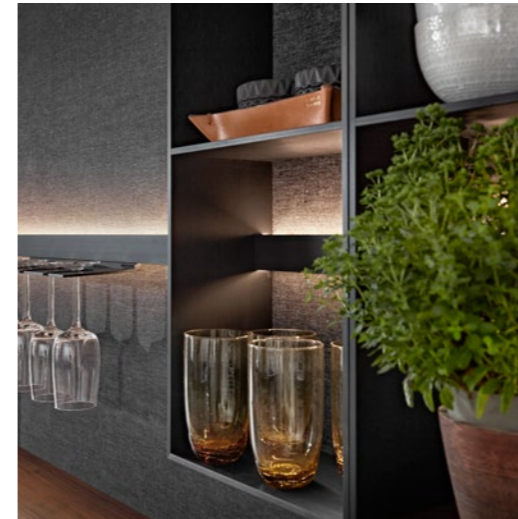

PLATE RACK FOR COTTAGE STYLE KITCHENS

Charming! Plate racks embody the country look and can transform your favourite plates into decorations. A wonderful idea for the kitchen or even the dining area.



05 — ADDITIONS FOR CUSTOMISATION



Everyone approaches organisation differently. What type of organiser are you? Creative and relaxed, highly structured or extremely precise? Our additions for customisation offer a whole host of ideas for adding your own personal touch to organisation – with shelf units, railing systems and new equipment options.



POLE-MOUNTED SHELVING SYSTEM

Aluminium support poles

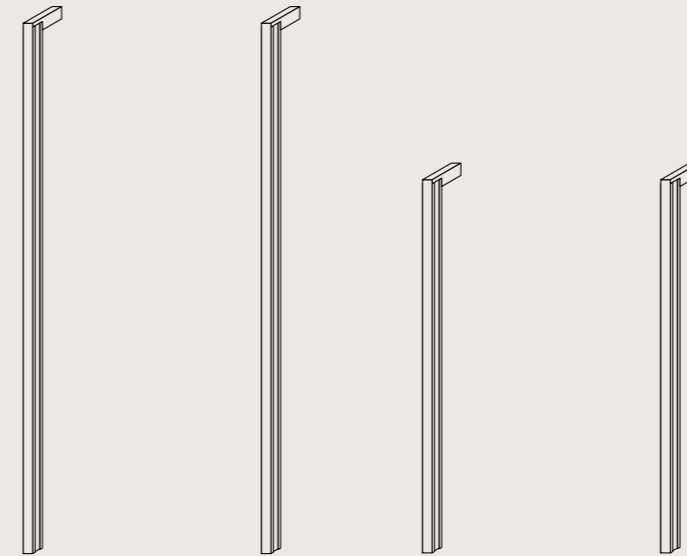

Support poles in tall unit height

Support poles in highboard height

Available support pole colours: black and stainless steel finish.
Available with optional LED light design.

Shelves and inserts

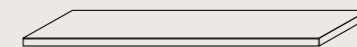
Shelf, 220 mm deep,
16 or 25 mm thick

Also available with a depth of 380 mm.

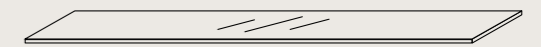
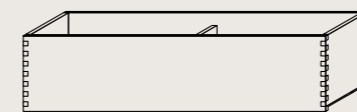
Shelf with Manila Plus
LED built-in lightGlass shelf, 220 mm deep,
8 mm thickWooden box,
150 mm tall, 170 mm deep

Also available with a height of 70 mm.

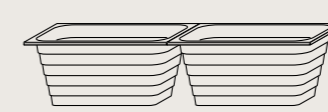
Herb pots for wooden box,
125 mm tall, 148.5 mm deep

Also available with a height of 45 mm.

Pull-out and wall units can also be
combined with pole-mounted shelving.

Three cheers for customisation options! Whether in the living room, the dining area or the kitchen, the pole-mounted shelving system is a multitasker that's open to just about anything. The system is based on support poles in black or a stainless steel finish, which are available in tall and dresser unit heights. Elements such as glass and wood shelves can be mixed and matched to meet your personal needs. You can also add a touch of green to your shelves with plant units and grow lights. Choose shelves with integrated LED lights or set the stage with support poles featuring lights. The choice is entirely up to you!

RAILING SYSTEMS: UNBELIEVABLY VERSATILE

For us, good design is always solution-oriented. One of our favourite examples is our railing systems. These versatile all-rounders adapt to your needs and can create additional space in the kitchen, bathroom or living room.



RAILING SYSTEMS

Our all-rounder – even in small spaces. Optimal for kitchens big and small, this system offers the perfect space for all your important kitchen utensils – so they're always within easy reach. Now's the time to configure your wall organisation system for your favourite utensils. The perfect match for your lifestyle and the kitchen.

SYSTEMATIC APPROACH TO OPENNESS: POSITION YOUR KITCHEN UTENSILS WHEREVER YOU PLEASE.



SIGN EMOTION

Flexible storage space meets design! Shelf units in various widths and heights as well as special features and organisational aids provide Sign Emotion with an unbelievable degree of flexibility. Each and every element can be hooked or hung at any position and moved around on the rail. There are also a whole host of features to choose from such as the magnetic knife rack, special holders for tablets, coffee capsules and kitchen roll, as well as a variety of versatile shelves. An additional socket is also an option.

Music fans will enjoy the holder for the Teufel MUSICSTATION.





SIGN EMOTION RAILING SYSTEM

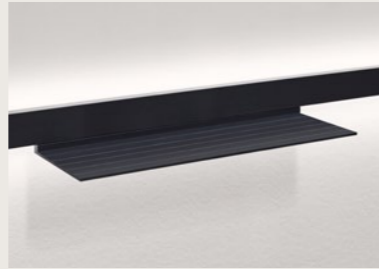

Universal storage shelf



Tablet holder



Small item tray



Capsule holder



Aluminium shelf unit with 1 or 4 shelves



Glass door for aluminium shelf unit



Paper roll holder and towel rail



Universal storage shelf



Wine glass holder



Magnetic knife rack



Adapter holder for the Teufel MUSICSTATION



Distributor box



Double socket



Set of hooks

The aluminium profile and all the accessory elements are available in black and a stainless steel finish.



Railing with LED lighting



Black

Incl. 4 hooks for 600 mm width.
 Incl. 6 hooks for 900 mm width.
 Incl. 8 hooks for 1,200 mm width.

Railing set



Stainless steel finish

Incl. 1 profile strip and hook rail for 600 mm width.
 Incl. 2 profile strips, 1 hook rail and paper roll holder for 1,200 mm width.
 Incl. 3 profile strips, 1 hook rail, paper roll holder and multi-purpose shelf for 1,800 mm width.

Linero-MosaiQ railing system



Magnetic knife rack



Hook rail



Top shelf



Quiver/
herb pot



Dish, flat



Universal storage shelf
with a height of 200 and 300 mm

200 mm model available
with frame.



Paper roll holder



Cling wrap cutter



Tablet holder

OTHER RAILING SYSTEMS

The aluminium profile is available in a stainless steel finish.
 The corresponding accessory elements come in black graphite.



A WIDE RANGE OF LIGHTING SYSTEMS

Light changes everything and allows us to continue working at night. Always energy-efficient, our LED lights for the kitchen come in many different forms and can be installed at many different locations. Our special highlight: We have joined forces with Philips Hue, the market leader in smart home lighting*, to develop the first Philips Hue recessed furniture lights especially for the kitchen. Control and dim your smart lighting with the app or voice command. The Philips Hue Bridge even allows you to set up as many as 50 lights in your home, across different rooms as well.

SMART HOME

Experience a unique lighting experience with the smart Philips Hue linear lights and recessed spotlights! Choose between warm and cold white light or switch to your favourite colour. With 16 million colours and preset lighting scenarios at your disposal, you'll always be able to find the perfect lighting for every mood and every situation.



* GfK, DE Q1 2024, Smart lighting in value



SET THE TONE WITH LED LIGHT: DIFFERENT LOCATIONS CREATE DIFFERENT EFFECTS.



WORK LIGHTING

Clear, bright and focused – good lighting optimises work in the kitchen and enhances the atmosphere. How about LED light panels and built-in lights integrated into the bottom shelf of tall units? Perfect for illuminating niches and worktops.



AMBIENT LIGHT

Controlled lighting can provide a pleasant atmosphere. Make a statement with lighted shelves or vertical lighting effects in wall units, the skirting board or the recessed handles. And suddenly everything feels warm and cosy.

CEILING LIGHTS

The innovative light solution for kitchen islands. The iLand LED ceiling light not only boasts extraordinary design, but can also provide direct or indirect illumination. Opt for a bright, glare-free working light to perfectly illuminate the work surface or hot plates with integrated extractor fan. Or enjoy a soft, atmospheric ambient light. iLand is controlled and dimmed by remote. Available in black or white to complement the look of your kitchen.



PRACTICAL ADDITIONS

Suitable additions can often increase convenience in the kitchen, which is why we're always developing cunning ideas to make daily life all the more pleasant as well as expanding our range, with a new variety of mobile, flexible and sometimes even entirely unexpected options.

NICHE SHELF UNIT WITH FLAP

These units will provide you with additional storage space in smaller areas. Small kitchen appliances, cutting boards, kitchen knives and more can simply disappear behind flap doors. Installation depth of 125 mm, body available in many different colours.



OUR TIP

INTERNAL TABLAR SHELF

An internal tablar shelf that can be integrated into tall and dresser units makes it a breeze to move kitchen devices around.



PULL-OUT TABLE

Space-saving solution for small kitchens. The base unit with pull-out table serves as a storage surface or a table for a coffee break. Maximum load 30 kg.



STEP STOOL

Open the drawer or pull-out, fold up the step stool and stow it away. But you can also hang the foldable aluminium step stool on the integrated universal bracket. Perfect for installation in base and tall units.

PLINTH DRAWER

Even the plinth offers storage space if you integrate the practical plinth drawer.



ELECTRIC ALL-PURPOSE SLICER

The electric all-purpose slicer makes preparing ingredients a breeze – and is suitable for a drawer width of 500 mm or more. When you're done, simply fold it up and stow it in a drawer to save space.





SOCKETS

Always there whenever you need them. Sockets for kitchen devices, smartphones and more can be positioned just about anywhere for easy access. Installed in the worktop or in niches, they simplify everyday work in the kitchen. Wireless charging offers a contemporary addition.



QUALITY FOR LIFE

We believe that only genuine quality can truly be sustainable, which is why we have made the decision to develop and produce our furniture exclusively in Germany. All the materials used undergo extensive testing with a focus on ensuring a service life of at least 15 years, and are inspected and certified by independent, international institutes. Quality that has won multiple awards and never fails to impress even years later.

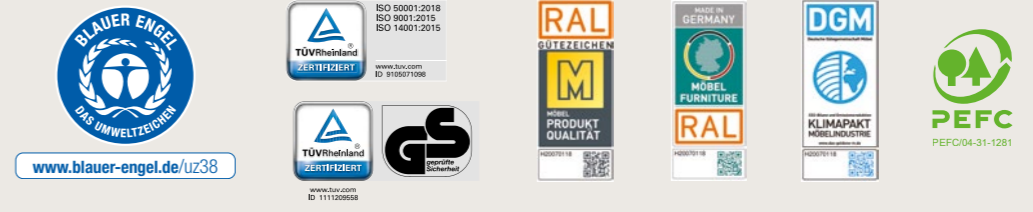



 /nobilia_de

 /nobilia_de

 /nobilia_official

 /@nobilia_de

nobilia-Werke
J. Stickling GmbH & Co. KG
Waldstraße 53-57
D-33415 Verl
info@nobilia.de
www.nobilia.de